

# Zeitschrift



1966 Volkswagen Karmann Ghia 1600.

**October 2021**

**IN THIS ISSUE:**

**Golf 8 GTI  
Karmann Ghia 1600  
Antarctica 1 film  
More Ash articles**

**Rack n Roll  
VW salt racer  
Australian VW Power  
Plus lots more...**



**The Legend Never Dies**

**Club VeeDub Sydney.**  
[www.clubvw.org.au](http://www.clubvw.org.au)

A member of the NSW Council of Motor Clubs.  
Affiliated with Motorsport Australia (CAMS).



# Club VeeDub Sydney Committee 2020-21.

<b>President:</b>	Steve Carter president@clubvw.org.au	0490 020 338
<b>Vice President:</b>	David Birchall vicepresident@clubvw.org.au	(02) 9534 4825
<b>Secretary and: Membership:</b>	Norm Elias secretary@clubvw.org.au	0421 303 544
<b>Treasurer:</b>	Martha Adams treasurer@clubvw.org.au	0404 226 920
<b>Editor:</b>	Phil Matthews editor@clubvw.org.au	0412 786 339
<b>Webmaster:</b>	Aaron Hawker webmaster@clubvw.org.au	0413 003 998
<b>Social Media:</b>	Lee Woods l.woods@hotmail.com.au	0414 952 509
<b>Book and DVD Librarian:</b>	Carl Moll library@clubvw.org.au	0417 471 137
<b>Tool Librarian:</b>	Bob Hickman hicko@inet.net.au	(02) 4655 5566
<b>Merchandising:</b>	Raymond Rosch sales@clubvw.org.au	(02) 9601 5657
<b>Assistant Merch:</b>	Kira and Bettina Rosch	
<b>Raffle Officer:</b>	Christine Eaton	(02) 9520 4914
<b>Vintage Registr:</b>	John Ladomatos vintage@clubvw.org.au	0449 236 076
<b>VW Nationals Committee:</b>	David Birchall Zelko Jurkovic, Eddie Fleita, Sandy Benic	(02) 9534 4825
<b>Trophy Engineer:</b>	Shirley Pleydon	
<b>Motorsport Captain:</b>	Rudi Frank motorsport@clubvw.org.au	0418 442 953
<b>VW Motorsport Committee:</b>	Craig Adams Eddie Fleita	Barry Parks
<b>General Committee:</b>	Barry Parks Sam Nadile Sandy Benic Joe Buttigieg	Charlie Attard Jeff Swords Zelko Jurkovic
<b>Canberra Committee.</b>		
<b>President:</b>	Dot Bryan	clubveedubact@gmail.com
<b>Secretary:</b>	Willie Nelson	clubveedubact@gmail.com
<b>Treasurer:</b>	Dave Cook	clubveedubact@gmail.com
<b>Registrar:</b>	Willie Nelson	clubveedubact@gmail.com
<b>Council/Events:</b>	David Cook & Lachy Patton	
<b>Social Media:</b>	Dorothy Bryan	clubveedubact@gmail.com

## Club VeeDub membership.

Membership of Club VeeDub Sydney is open to all Volkswagen owners. The cost is \$45 for 12 months.

## Monthly meetings.

Monthly Club VeeDub meetings are held at the Arena Sports Club Ltd (Greyhound Club), 140 Rookwood Rd, Yagoona, on the **third Thursday of each month**, from 7:30 pm. All our members, friends and visitors are most welcome.

## Correspondence.

Club VeeDub Sydney  
PO Box 324  
Mortdale NSW 2223

## Facebook:

[www.facebook.com/ClubVeedubSydney/](http://www.facebook.com/ClubVeedubSydney/)  
[www.facebook.com/clubveedubcanberra/](http://www.facebook.com/clubveedubcanberra/)



## Our magazine.

**Zeitschrift** (German for 'magazine') is published monthly by Club VeeDub Sydney Inc. We welcome all letters and contributions of general VW interest. These may be edited for reasons of space, clarity, spelling or grammar. Deadline for all contributions is the first Thursday of each month.

Opinions expressed in Zeitschrift are those of the writers, and do not necessarily represent those of Club VeeDub Sydney. Club VeeDub Sydney, and its members and contributors, cannot be held liable for any consequences arising from any information printed in the magazine.

Back issues (2006-on) are available at [www.clubvw.org.au](http://www.clubvw.org.au) under the Media - Zeitschrift tag.

Articles may be reproduced with an acknowledgment to *Zeitschrift, Club VeeDub Sydney*.

## We thank our VW Nationals sponsors:

### 33 years.

Andrew Dodd Automotive  
H&M Ferman  
Stan Pobjoy Racing Engineering

Vintage Vee Dub Supplies  
Volksbahn Autos Pty Ltd

### 25 years and over.

Aust VW Performance Ctre  
Mick Motors  
North Rocky & Import Parts

Shannons Car Insurance  
Wolfsburg Motors St Peters

### 20 years and over.

Harding Performance Cars  
Evolution Car Hire

Mobile Model Cars and Toys  
Wayne Penrose Automotive

### 15 years and over.

All Metal Bumpers  
Black Needle Motor Trimming  
BWA Auto

VW Magazine Australia  
Wolfsburg Auto Melbourne

### 10 years and over.

Antique Tyres  
Artemi's T-Shirts  
Canberra VW Centre  
Custom T Shirts  
Euro Automotive  
MacKellar Service Centre  
Just Kampers

Motexion  
Mountain Mechanics  
Rod Penrose Racing  
Quik Strip  
Volkshome Automotive  
Volkscare  
Warby's Stickers

See the back page for all 2021 VW Nationals sponsors.

*Please have respect for the committee members and their families  
by only phoning at reasonable hours.*

KELSO OVAL PANANIA

# EAST HILLS CHARITY

## CAR SHOW

SUNDAY 31ST OCTOBER 2021



The East Hills Charity Car Show is a community based event which attracts car lovers from all over NSW. Prizes are offered in a wide range of categories. A great family day out with the goal of the event to support a different charity each year.



This year the East hills Charity Car Show is extremely proud to be supporting the Crohn's & Colitis Australia  
[www.crohnsandcolitis.com.au](http://www.crohnsandcolitis.com.au)



[www.easthillscarshow.com.au](http://www.easthillscarshow.com.au)

# ARMWARD TO VICTORY



**DON'T WAIT. VACCINATE.**



## Von dem Herrn Präsident.

Hi all, well there finally seems to be a bit of light at the end of this long horrible covid tunnel. Once we get to 70% and 80% double vaccinations we can get our lives back to some sort of normality. In NSW we will have gradual reopening of clubs and pubs, but not quite yet. It will be up to the Arena Greyhound Club, where we hold our meetings, as to what restrictions they will impose regarding proof of vaccination and number of patrons allowed. You can keep an eye on their website here, but I don't know how often they update it:

[www.arenasportsclub.com.au](http://www.arenasportsclub.com.au)

It looks like October is too soon to have meetings, but hopefully we can get back to having committee meetings and club meetings not too long after, possibly in November. Watch your email in-box for updates as soon as we know.

The East Hills Car Show has been postponed yet again – it is now scheduled for Sunday 31 October. We should be past the 80% milestone by then and hopefully it can go ahead.

Boris' Picnic Day is also still up in the air until we can have large outdoor gatherings. I think it will be impossible to get council permission to hold it at our usual venue at Ramsgate beach, but Boris might come up with another location. Stay tuned.

In the meantime we have another excellent club magazine for you to enjoy. Never before have we had so much material submitted by our members – Phil says he already has enough articles for the next TWO issues. Thank you to our regular contributors Ash, Carl, Rod, Dave and Jeff for all your submissions. Even I couldn't resist sending in a couple of articles for next month. Just be aware that if you send Phil an article or news item, it might be a couple of months before it gets printed, such is the huge backlog.

Our printer Bruce at Minuteman at Peakhurst has been doing an excellent job on our magazine since 2014, but soon his contract with Minuteman will expire. Fortunately Bruce will be able to continue producing our printed magazine by working from home – thank you Bruce.

We are still looking for our members to submit stories and photos of their VWs for our updated website. Go to [www.clubvw.org.au/media/member-cars/](http://www.clubvw.org.au/media/member-cars/) to see the stories already there. Would you like to see your wonderful VW there? Just email Phil your story and a few photos to [editor@clubvw.org.au](mailto:editor@clubvw.org.au) and it will be there for everyone to enjoy.

In the meantime, hopefully we can soon have events taking place, so keep an eye on your emails and club website for developments with upcoming events.

See you soon,

Steve Carter



## Kanberra Kapitel report.

Greetings from the Nation's Capital, As I reported last month, there is once again very little to report this month. The ACT has been in lockdown since 12 August, with the plan (at time of writing) to emerge from it (with restrictions) on 16 October. It was extended to include the school holiday and then some, when new case numbers did not reduce. I'm sure by the time this edition hits the streets, this information will have changed yet again.....

The date we should have conducted the Act German Auto Day (GAD) has been and gone, with a few of us posting photos of previous GADs on our Facebook page, in memory of what great events these are. If anyone would like to post their memories on the Facebook page, please do so. There is no such thing as too many pictures of VWs and VW shows. As a reminder, the Canberra Facebook page is: **Public Group - Club VeeDub Canberra Chapter.**

Also cancelled and reported in the last edition of Zeitschrift is the annual Cookies Fish & Chip Run. These are just a couple of the local car shows / events that have been cancelled due to the current pandemic. Canberra historically has many car shows and events to choose from in spring, as the weather is just perfect for such events. We are hoping that events planned for later in the year can go ahead, even with a few restrictions in place for outdoor events. At this stage the annual Marques in the Park, planned for 14 November 2021 has not been cancelled or postponed, so we hope to attend this show with a huge contingent of VeeDubs. Keep an eye on the Facebook pages for information as it comes to hand.

As reported last month, all monthly club meetings for the Canberra Chapter are cancelled until we come out of lockdown and are allowed to gather for such activities. We will advertise on our Facebook page when these resume.

Once our lockdown is lifted, we plan to conduct more ad-hoc coffee meets to give us an excuse to get our VeeDubs out, take advantage of the beautiful weather and to socialise with other car enthusiasts. Keep an eye on the Facebook pages for any of these activities. Remember to click on the Events tab, as sometimes the notices are placed on there and don't show on your regular feed.

Stay safe and stay well. I look forward to seeing you all out in our VeeDubs in the not-to-distant future.

Willie

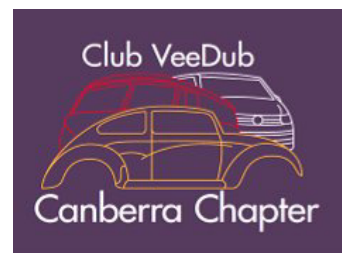

## Klub Kalender.

**\*\*\* All information correct at time of printing but subject to change - events are sometimes altered or cancelled without notice.**

**Check [www.clubvw.org.au/events](http://www.clubvw.org.au/events) for the latest information and any changes.**

## October.

**Thursday 14th:- Committee Meeting** and magazine pack \*\*\*  
CANCELLED DUE TO COVID LOCKDOWN \*\*\*

**Thursday 21st:- CLUB VW MONTHLY MEETING \*\*\***  
CANCELLED DUE TO COVID LOCKDOWN \*\*\*

**Sunday 31st:- East Hills Charity Car Show** at Kelso Oval, Panania (COVID PERMITTING). All classic makes and models welcome. Trophies to be won in numerous categories. Show cars enter through the gates on Marco Ave, off Childs St. A great family day out, food and drink stands, music and entertainment, motor accessory traders. Phone Glen on 0434 360791 for more info. **Join the Club VW convoy at McDonalds Moorebank (Newbridge Rd) at 8:00am for an 8:30 departure.** [www.easthillscarshow.com.au](http://www.easthillscarshow.com.au)

## November.

**Monday 1st:- Canberra General Meeting** at the Harmonie German Club, 49 Jerrabomberra Avenue, Narrabundah, from 7:30pm.

**Thursday 4th:- Magazine Cut-off Date** for articles, letters and For-Sales.

**Thursday 11th:- Committee Meeting** and magazine pack at the Arena Greyhound Sports Club, 140 Rookwood Rd. Yagoona (next to Potts Park), 7:30pm.

**Thursday 18th:- CLUB VW MONTHLY MEETING at the Greyhound Social Club**, 140 Rookwood Rd. Yagoona (right

next to Potts Park). Get the latest VW news and views, plus VW socialising, drinks, raffles, trivia and plenty of prizes. Lots of fun, all welcome. 8:00pm start.

## December.

**Thursday 2nd:- Magazine Cut-off Date** for articles, letters and For-Sales.

**Monday 6th:- Canberra General Meeting** at the Harmonie German Club, 49 Jerrabomberra Avenue, Narrabundah, from 7:30pm.

**Thursday 9th:- Committee Meeting** and magazine pack at the Arena Greyhound Sports Club, 140 Rookwood Rd. Yagoona (next to Potts Park), 7:30pm.

**Thursday 16th:- CLUB VW MONTHLY MEETING at the Greyhound Social Club**, 140 Rookwood Rd. Yagoona (right next to Potts Park). Get the latest VW news and views, plus VW socialising, drinks, raffles, trivia and plenty of prizes. Lots of fun, all welcome. 8:00pm start.

## January 2022.

**Monday 3rd:- Canberra General Meeting** at the Harmonie German Club, 49 Jerrabomberra Avenue, Narrabundah, from 7:30pm.

**Thursday 6th:- Magazine Cut-off Date** for articles, letters and For-Sales.

# We'd like to see your VOLKSWAGEN!

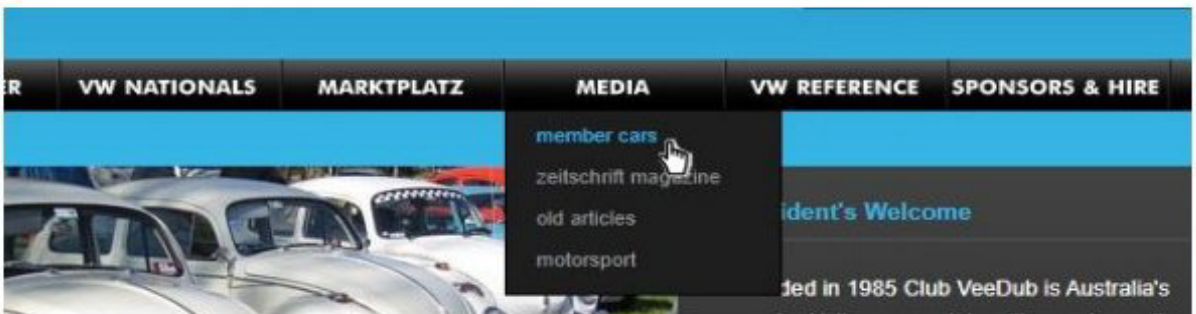

With covid lockdown stopping meetings and events for who knows how long, it's now a good time to display your Volkswagen on our webpage!

Go to [www.clubvw.org.au](http://www.clubvw.org.au) and click on the **Media / Members cars** tag above.

If you'd like to see your VW featured here, it's easy—just write a short story

about your VW—where you found it, what you've done to it, how you fixed it up or restored it, what's special about it—and why you love it.

Just email your story to [editor@clubvw.org.au](mailto:editor@clubvw.org.au)

Don't forget to attach some nice JPG photos of your VW !

**Thursday 13th:- Committee Meeting** and magazine pack at the Arena Greyhound Sports Club, 140 Rookwood Rd. Yagoona (next to Potts Park), 7:30pm.

**Thursday 20th:- CLUB VW MONTHLY MEETING** at the **Greyhound Social Club**, 140 Rookwood Rd. Yagoona (right next to Potts Park). Get the latest VW news and views, plus VW socialising, drinks, raffles, trivia and plenty of prizes. Lots of fun, all welcome. 8:00pm start.

## Marktplatz.

*Marktplatz ads in Zeitschrift are free. All ads should be emailed to [editor@clubvw.org.au](mailto:editor@clubvw.org.au)*

*All ads will be published here for two months. All published ads will also appear on our club website, [www.clubvw.org.au](http://www.clubvw.org.au).*

*Photos can be included if you provide a JPG. All ads will appear in Zeitschrift first so our members have first chance to see them. They will then be transferred to the club website on the third Thursday of the month.*

## New ads.

**Wanted: VW storage.** I am a club member looking to store a VW car in western Sydney (Penrith area). Do you have a warehouse or shed I could hire or borrow? Please let me know if you can assist. Carl 0417 471137



**For Sale:- 1973 VW Superbug L (L-Bug).** Very good condition, excellent interior, Saas seats, wood-rim steering wheel, suspension mods, 4-wheel discs brakes, BRM alloys ,twin kadrons, electronic ignition, Rego till Dec. \$16,000. Ph Kevin 04318 296861 or email [brady449@hotmail.com](mailto:brady449@hotmail.com)

**For Sale:-** I have been the proud owner of many VWs both in Australia and overseas and currently have a T5 camper. In the 1990s I drove a VW Westfalia camper van 160,000 miles around 48 American states on my own over about 6 years, breaking down all over the place and having a lot of extraordinary adventures. I have just published a book which I thought might be of interest to your members. It's called 'Chasing Music - My Crazy Campervan Adventures in



America.' I self-published (through a professional publisher) and now face the task of letting people know about it, especially other VW owners. It is available for purchase from on-line sellers Booktopia, Amazon, Fishpond, BookDepository and Ebay for around \$30. Here's a link: [www.booktopia.com.au/chasing-music-jan-dale/book/9781922465559.html](http://www.booktopia.com.au/chasing-music-jan-dale/book/9781922465559.html)  
You can also contact me directly at [jdale@netspace.net.au](mailto:jdale@netspace.net.au)  
Looking forward to hearing from you! Kind regards Jan Dale, Mentone Victoria





**For Sale:-** I have a 1972 VW Beetle 1300 that I wish to sell. Unregistered and has a small amount of rust in one spot and a dint near the headlight. Other than that , it is in lovely condition and runs well. Has mag wheels, original engine and a CD player. Interior is great. Colour is lavender. I live in Port Stephens. I have been told to hold on to it as an investment and although I love it, I never drive it. Would love to see it go to someone who would enjoy it. \$15,000 ONO. Thanks for your time. Please contact Donna on 0488 660676 or email [donnabeckhouse@live.com.au](mailto:donnabeckhouse@live.com.au)

**Wanted:-** I'm hoping to buy a 6n Polo (1994-2000) in either Tornado Red or Chagall Blue. Preferably a manual with low kilometers and in good condition. I'm located in the Newcastle region, bonus if the car is close but I am open to travelling once restrictions ease. If you or someone you know may be thinking about passing the car on, please contact me on 0419 983 706 or send me through an email to [Stevejameswar@gmail.com](mailto:Stevejameswar@gmail.com)

## 2nd Month ads.

**Notice:** Dear Friends who like Volkswagen Beetle, Kombi and other models with air cooled engines...how are you? My name is Renato and I'm in Brazil - land of the last Volkswagen Beetle and Kombi factories. Our company is TRL Internacional - [www.trlinternacional.com.br](http://www.trlinternacional.com.br) - we are specialists in searching and exporting Volkswagen. Want to increase your collection? Do you want to fulfill your dream of owning an original Brazilian Volkswagen? Talk to me and let's work together! Email me at [renato@trlinternacional.com.br](mailto:renato@trlinternacional.com.br) and I will help you. Best regards Renato



**For Sale:-** 2012 Tiguan bull-bar. It's a steel East Coast Bullbar with Roolite driving lights. Includes all mounting hardware and wiring harness. \$500. Located in Elimbah, QLD. Please contact Phillip Dunn on 0448 807105 or email [dunnworking@aussiebroadband.com.au](mailto:dunnworking@aussiebroadband.com.au)

# Volkswagen Owners

## FREE VOLKSWAGEN SERVICE SAFETY CHECK



**ABSOLUTELY FREE**

NO OBLIGATION

**AT OUR SERVICE DIVISION  
THURSDAY & FRIDAY,  
NOVEMBER 19 & 20**

From 8 a.m. in the morning to 5 p.m.  
in the afternoon  
57-POINT DETAILED WRITTEN REPORT  
CONDUCTED BY VW FACTORY ENGINEER



Authorised Service

# WARDS MOTORS

WESTERN HIGHWAY, PENRITH  
(NEAR THE BRIDGE)

Phone: **22321**



## Trades and services directory.

## Trades and services directory.

### ANDREW DODD AUTOMOTIVE THE ENTHUSIAST VW SPECIALIST

Specialising in:  
Engine Reconditioning, Brakes, Front End Work, Servicing & Modifications to VW Beetle, Kombi, Type 3, Golfs & Passats.

**40 YEARS VOLKSWAGEN EXPERIENCE**

We are located at:  
Units 54 & 55/2 Richard Close  
North Rocks (Off Loyalty Rd)

**PH: (02) 9683 2184**

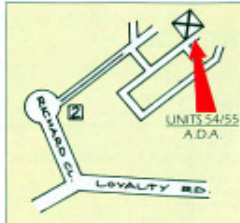

Unit 1  
11B Harp Street  
Campsie NSW  
Australia 2194



Tel: 02 9789 1777

Fax: 02 9718 8704

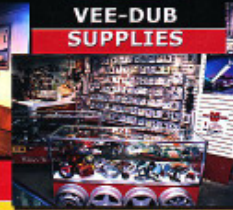

**VEE-DUB SUPPLIES**

**KOMBI GHIA TYPE III BEETLE**

**KYE GENE BERG**

**WWW.VINTAGEVEEDUB.COM.AU**

## H&M FERMAN AUSTRALIA

**Original Equipment Manufacturers & Designers for the Motor Industry**

Warwick Blackwood  
National Sales Manager

99-105 Boundary Road  
Peakhurst NSW 2210  
Sydney Australia  
[www.hasmot.com](http://www.hasmot.com)

**hasmotek**  
AUSTRALIA

Ph: +61 (0) 2 9533 2722  
Fax: +61 (0) 2 9153 6033  
Mob/Cell: +61 (0) 415 263 029  
Email: [warwick@hasmot.com](mailto:warwick@hasmot.com)  
Email: [hasmot.vw@gmail.com](mailto:hasmot.vw@gmail.com)

## Stan Pobjoy's Racing Engineering P/L

All engines are precision machined and personally built by Stan Pobjoy, guaranteeing you professional engine build quality and exceptional performance.  
Power your VW with a Pobjoy engine today!

**02 6654 3694**

Stan Pobjoy's Racing Engineering Pty Ltd  
1252 Orara Way, Nana Glen, Coffs Harbour NSW 2450

## INSURANCE FOR MOTORING ENTHUSIASTS

CALL 13 46 46  
[SHANNONS.COM.AU](http://SHANNONS.COM.AU)



SHARE THE PASSION

## IMAGINE THE BIGGEST & BEST DISPLAY IN AUSTRALIA OF NOS & NLA STOCK

REPUTED TO HAVE THE LARGEST STOCK IN THE WORLD

**Volkswagen Autos**



PHONE FOR PRICES & STOCK

**(02) 9688 2933 6 DAYS**

FULL MAIL ORDER SERVICE

[www.volkswagen.com.au](http://www.volkswagen.com.au)



**MICK MOTORS**

96 Toombul Rd  
Northgate QLD  
Australia 4013

Ph +61 07 3266 8133

**Volkswagen Spare Parts**

Fax +61 07 3260 5179

[mick@mickmotors.com.au](mailto:mick@mickmotors.com.au)

67 CAMPBELL ST  
ST. PETERS, NSW 2044

JAN BANGMA

Email:  
[wmooffice@tpg.com.au](mailto:wmooffice@tpg.com.au)

Phone:  
9519 4524

VOLKSWAGEN - AUDI



## Trades and services directory.

## Trades and services directory.

### AUSTRALIAN V DUB PERFORMANCE Centre

Australian VW Performance Centre is located in Croydon South, about 30 minutes east from the Melbourne CBD, close to Ringwood end of Eastlink. If you find yourself unable to contact us during business hours, please do not hesitate to email us with any enquiries you have.

[vwperformance.com.au](http://vwperformance.com.au)

Address: 29 Research Drive, Croydon South, Victoria, 3136

Phone: (03) 9761 4540 or (03) 9761 7917

Fax: (03) 9761-6216

Email: [avwpc@vwperformance.com.au](mailto:avwpc@vwperformance.com.au)



### North Rocky Mechanical & Import Parts



43 Quinn Street

North Rockhampton Q 4701

P.O. Box 5732 CQMC 4702

Gordon & Maree Fischer

Ph. (07) 4922 0111 Fax. (07) 4922 0555

Automotive Servicing Specialists

### HARDING PERFORMANCE HP

Guy Harding

1/56 Cambridge St,  
Coorparoo Qld 4151  
[www.hp.net.au](http://www.hp.net.au)

T 1300 730 949  
P +61 7 3394 1200  
e [guy@hp.net.au](mailto:guy@hp.net.au)



Robert 0418 662 915

Tereza 0419 494 465

PO Box 200  
Blacktown NSW 2148

Shop 2a, 12 Romford Rd  
Kings Park NSW Australia

[evolutioncarhire.com](http://evolutioncarhire.com)  
[evolutionhire@optusnet.com.au](mailto:evolutionhire@optusnet.com.au)



### MOBILE AUTO MODELS & TOYS

Specialising in diecast model cars

STEVE

Ph: 9543 5364  
Fax: 9543 2649  
Mob: 0403 012 060

[mobilemodels@bigpond.com](mailto:mobilemodels@bigpond.com)



### WAYNE PENROSE VOLKSWAGEN CITY LTD

Home of the Multi Award Winning "MANGO DREAM"

Marley Place (P.O. Box 1096) Unanderra 2526

(02) 4272 5844  
(02) 4272 5644  
0419 481 461



### ALL METAL BUMPERS

Unit 1/17 Memorial Avenue, INGLEBURN

Phone: 9605 1044

Specialising in Restoration, Customisation & Repair of Auto, Marine & Commercial Vehicles.

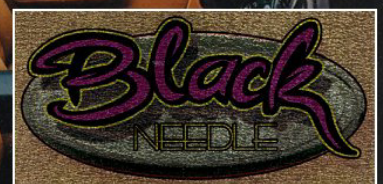

MARK: (02) 4722 5333 [www.blackneedle.com](http://www.blackneedle.com)  
Unit 38 / 37-47 Borec Rd, Penrith. 2750

## Trades and services directory.

## Trades and services directory.

Australia's Air & Water Cooled VW Magazine!

**CRAIG HUGHES**

VW Magazine Australia  
PO Box 3551  
Loganholme  
QLD 4129

Phone: 0419 735 596  
info@vwma.net.au  
www.vwma.net.au





**VAPOR BLASTER**

0467 697 433

Unit 2 / 43 Fairfield St  
Old Guildford, NSW 2161

**Bob Whyms**  
Managing Director

**BWA**auto

E kwhyms@bigpond.net.au  
M 0418 651 620  
T 02 9838 7373  
F 02 9838 7606

45 Prince William Drive  
Seven Hills NSW 2147

**European Service and Parts Specialist**

**AudiSport**  
**Wolfsburg Automotive**

All things for Volkswagen Audi group Vehicles

**VW - AUDI - SEAT - PORSCHE - SKODA**  
**NEW PARTS REPAIRS WRECKING**

★ Servicing Australia with quality parts at best possible prices ★  
★ Servicing & Repairs done to a standard rather than price. ★

**17-21 Seaforth St, North Shore, VIC 3214**  
**Ph: (03) 9988 0799 Ph: 1300 370 310**  
**E-mail: parts@vw4.me**

ABN 20 095 354 260

## Club Veedub Sydney Membership / Subscription Form. ✂

New Member:  Renewal:

Name:

Address:

State:  Postcode:

Email:

Phone:  (BH)  
 (AH)  
 (Mob)

Do you want to participate in CAMS motor sport?  NO  YES

Which of the following activities are you interested in? Please number in order:

- Cruises and observation runs
- Show n Shines, Concours
- Swap meets (VW parts)
- Social days and/or nights out
- Drag or track racing
- Meetings and tech talks
- Other (you tell us!):

\_\_\_\_\_

\_\_\_\_\_

**Trades and services directory.**

**Trades and services directory.**

mobile bar. **Kombi Keg**

0419 363 922  
www.kombikegnorthwestsydney.com.au

Six icy cold taps for all your favourites - Draught Beer, Cider, Wine, Cocktails, Soft Drink & more!

Pop-up roof TV to display photos, branding, videos or even watch the footy!

Weddings Engagements Hens & Bucks Birthdays  
Corporate Functions Brand Activations Festivals Shows

**Club Veedub Merchandise**  
For club polo shirts, jackets, hats, mugs, etc.  
**Contact Raymond Rosch**  
(02) 9601-5657

Club VeeDub Membership, Sponsorship and Merchandise payments can be made securely online via PayPal. You don't need an account but there is a small fee for the service. Please visit our web site at [www.clubvw.org.au](http://www.clubvw.org.au) or email Raymond at [sales@clubvw.org.au](mailto:sales@clubvw.org.au) for more information.

**Beetle glovebox lid pull handle.**

Australian made to suit early (pre 68) VW. High quality stainless steel polished to a show winning shine.

\$37 posted within Australia.

Enquiries  
Carl Moll  
[carlmoll@iinet.net.au](mailto:carlmoll@iinet.net.au)  
0417 471 137

**Wanted:** 

Your business ad in this space. The cost for 11 months is \$110 - this does not include the VW Nationals issue. Post your business card and a cheque for \$110 to the Secretary, Club Veedub Sydney, PO Box 324, Mortdale NSW 2223



**Club Veedub Sydney Membership / Subscription Form.**

Please tell us about your Volkswagen(s):

Year	Model	Engine Size	Rego No.	Colour

Please enclose a cheque or money order for \$45.00, payable to Club Veedub Sydney, and post it with this form to:

Club Veedub Sydney,  
PO Box 324  
Mortdale NSW 2223

You will receive 12 issues.



Volkswagen's latest design themes seen on the new Golf hatch and smaller Caddy van, with standard-fit LED headlights up front - connected by a full-width daytime-running light bar across the nose - able to be upgraded to IQ.Light matrix LED units as an option.

The lower front bumper adopts a body-coloured mesh look inspired by the new Caddy, while at the rear there's a prominent roof spoiler, slim LED tail-lights and 'MULTIVAN' badging below the licence plate.

A panoramic glass roof can be optioned - with LowE laminated glass claimed to reduce incoming thermal radiation by 44 per cent - as can an electric tailgate and power-sliding doors with gesture control.

## 2022 T7 Multivan.

The 2022 Volkswagen Multivan has been officially unveiled, though an Australian launch is yet to be locked in.

Headlining the new generation Multivan's changes is a move to Volkswagen's ubiquitous MQB platform, shared with the Golf small car, Tiguan mid-size SUV, Caddy small van, Passat and Arteon and numerous other VW Group cars.

However, its adoption of the new underpinnings means the next generation Multivan will become the first in the model's history not have come from an equivalent Transporter van, which will instead be co-developed with Ford as a twin under the skin to the next Ford Transit Custom, as reported earlier this year.

The current T6.1 Transporter will continue in production alongside the new T7 Multivan, to fill the gap to the Ford-developed van's unveiling in 2023.

The switch to the MQB architecture has opened the door to an eco-friendly 'eHybrid' plug-in hybrid option for the first time, combining a 110 kW/250 Nm 1.4-litre turbocharged four-cylinder petrol engine with an 85 kW electric motor to develop a combined 160kW.

Drive is sent to the tarmac through a six-speed dual-clutch automatic transmission, with a 13 kWh lithium-ion battery providing juice for the electric motor - though a zero-emissions range figure hasn't been confirmed.

Both 100 kW 1.5-litre and 150 kW 2.0-litre turbocharged four-cylinder petrol engines will also be offered (without plug-in assistance), followed by a 110 kW turbo-diesel due in 2022. All non-hybrid engines will drive the front wheels through seven-speed dual-clutch automatic transmissions, with a manual gearbox no longer on offer.

Measuring 4973 mm long, 1941 mm wide and up to 1903 mm high in standard guise, with a 3124 mm wheelbase, the new Multivan is 69 mm longer overall, 37 mm wider, 67 mm lower and 121 mm longer in wheelbase than the short-wheelbase version its predecessor.

A long-wheelbase model is also available for the new generation, this time measuring 5173 mm overall. Alloy wheels up to 19 inches in diameter are available, with three variants on offer in Europe: the base 'Multivan' (no badge), mid-spec Life and higher-grade Style.

On the outside, the new Multivan adopts

Inside, 469 litres of space can be found behind all three rows in the short-wheelbase, increasing to 1850 litres with the third row folded (and the panoramic roof optioned), and 3672 litres with the second row removed. The lattermost figure increases to 4053 litres in the 5173 mm long-wheelbase variant.

Up to seven seats can be specified, with the second row claimed to be capable of rotating 180 degrees for a "conference-style seating configuration". Both second and third rows are claimed to be 25 per cent lighter than before, and can be removed entirely.

These can be paired with a new multi-function table, which can double as a work table for rear passengers, or a centre console for front-row occupants. Fully removable, the table's height can be adjusted, and features three cup holders and a storage compartment.

Making the sliding table possible is the introduction of a flat floor and deletion of a traditional front centre console, enabled by the switch to an electric parking brake and a 'shift-by-wire' automatic gear selector mounted on the dashboard.

Greeting front passengers is a pair of displays - a 25.5-cm infotainment touchscreen with satellite navigation, and a 26-cm 'Digital Cockpit' instrument cluster - integrated into one flowing gloss black panel, featuring a similar array of capacitive touch buttons as the latest Golf and Caddy.

The multi-function steering wheel adopts Volkswagen's latest design with touch-based buttons, while a head-up display in front of the driver is available - claimed to be a first for a Volkswagen Commercial Vehicles model.

Other available interior features include wireless smartphone charging, heated seats, two USB-C ports up front,





a 14-speaker, 840-watt Harman Kardon premium sound system with amplifier, an integrated eSIM for connected features, and support for a smartphone app allowing the vehicle to be locked/unlocked remotely, or have its climate control pre-set.

A total of 34 driver-assistance systems are said to be on offer, including Volkswagen's Travel Assist function, which combines adaptive cruise control and lane-centring assist to accelerate, brake and steer the Multivan within its lane on freeways at up to 210 km/h.

There's also autonomous emergency braking with intersection support, safe exit warning, traffic-sign recognition, cross-wind assist, a 360-degree camera, and Car2X functionality, which allows vehicles equipped with the system to communicate upcoming hazards to one another and European highway infrastructure.

The 2022 Volkswagen Multivan will go on sale in Europe later this year.

It will form part of a renewed Volkswagen mid-size van and people mover range, comprising the existing Transporter T6.1, new Multivan T7 (we don't know if there will also be a new model called the 'Caravelle') and, in 2022, production versions of the ID. Buzz and ID. Buzz Cargo concepts.

As for an Australian launch, a Volkswagen Australia spokesman said: "It's currently under investigation for Australia, but naturally we'd love to offer it. [The] T6.1 continues to set sales records this year, so we definitely see an appetite for a new Multivan model."

## Electric VWs delayed.

Volkswagen's expanding European fleet of ID electric vehicles are no closer to Australia, as the local VW office claims regions with stricter emissions regulations continue to be prioritised over our "automotive third world."

A Volkswagen Australia spokesperson recently said: "We've said previously 2022; [that has] slipped back to 2023, [and it] may even be later than that.

"Zero-emissions vehicles will be prioritised for those markets that have targets to meet. Demand is growing exponentially in Europe - 212,000 electric (EV) and plug-in hybrid (PHEV) Volkswagen vehicles were sold last year, [with] EVs a greater proportion of that holistic mix.

"Here there is no CO2 target, latent hostility to EVs [and] Victoria has taxed a new technology that is barely here

... [it has] not [been] thought through ... We don't ask for incentives. And we don't ask for disincentives."

Whereas Europe, China, the US and many other global markets carry strict emissions regulations and targets on CO2, fuel economy and other metrics - necessitating the sale of electric vehicles to balance out combustion-engined vehicles' emissions - Australia has no such targets.

Instead, petrol and diesel vehicles in Australia must only conform to Euro 5 standards, introduced in 2009, and around a decade behind the latest Euro 6d standards in effect in Europe.

Volkswagen's European electric vehicle range currently consists of Golf-sized ID.3 hatch and Tiguan-sized ID.4 medium SUV models, with

plans for an sub-25,000 Euro (AU\$39,000) ID.1 city hatch in 2025, ID.5 mid-size coupe SUV later in 2021, ID.7 mid-size sedan and wagon around 2023, and a production version of the ID. Buzz concept around a similar time.



A performance GTX version of the ID.4 was unveiled in April, while China recently received an all-electric seven-seat SUV to call its own, the not-for-Europe ID.6.

While Volkswagen might not sell an electric vehicle in Australia, fellow Volkswagen Group brands Porsche and Audi offer Taycan and E-Tron electric models respectively - more expensive upmarket models than potential VWs.

## Takata airbase case dismissed.

In a decision regarded by the car industry as a victory for common sense, the Supreme Court of NSW has dismissed a civil class action against Volkswagen over potentially faulty Takata airbags that had been replaced during a recall - and which had not been deemed responsible for any fatalities here or overseas.

The plaintiff claimed Volkswagen vehicles were "not of acceptable quality for the purposes of ... Australian Consumer Law" because certain airbags "had propensity to degrade when exposed to moisture and temperature fluctuations."

However, the court was told the plaintiff had no problem with the airbag in his vehicle and it had not been involved in an incident that would have caused the airbag to



deploy.

In a decision handed down on 18 June 2021 in the NSW Supreme Court - *Dwyer v Volkswagen Group Australia* - Justice James Stevenson said: "For the reasons that follow, I am not able to accept any of the bases on which the plaintiff put his damages claim."

The court heard Volkswagen Germany had tested some 20,000 potentially faulty Takata airbags fitted to vehicles built since 2005 - sourced from various climates and regions around the world - but all had deployed as the manufacturer intended.

Justice Stevenson said: "Had (the plaintiff) been involved in such an accident, whether before or after his original airbag was replaced, I see no basis to conclude that the airbag would have operated in anything other than in the way it was designed to operate."

In summary, Justice Stevenson said: "There is thus no evidence that, in fact, the airbag in his car would not have deployed as intended."

Further, Justice Stevenson said: "The plaintiff is only entitled to damages for the loss that he has actually suffered."

Volkswagen Australia replaced the Takata airbag in the plaintiff's car in 2019 - at no cost to the plaintiff - during the vehicle's 60,000km service. "The plaintiff incurred no out of pocket expenses while the airbag in his car was being replaced," said Justice Stevenson.

Even though there were no reports of Takata airbags deploying incorrectly - and no Volkswagen cars were recalled as part of the Takata safety campaign in Europe - Volkswagen nevertheless joined the Takata recall locally, at the instruction of the Australian Competition and Consumer Commission (ACCC), and recalled some 101,759 Volkswagens, 38,978 Audis, and 17,595 Skodas.

The landmark ruling is likely to set a precedent for other vehicle manufacturers who have replaced, repaired, or rectified potentially faulty components that have been the subject of a recall.

A statement from Volkswagen Australia said in part: "As was shown in evidence, there have been no incidents reported of a Takata airbag rupture in any relevant Volkswagen vehicles in the field globally. In compliance with the mandatory recall notice issued by the Australian Government, Volkswagen Group Australia replaced the Takata airbags that were subject of the proceeding at no cost to the owner."

Although the Takata airbag scandal involved two dozen brands and more than 100 million vehicles globally - including more than 3 million cars and more than 4 million airbag inflators in Australia, it's understood five other

manufacturers - namely Toyota, Honda, Nissan, Mazda, Subaru and BMW - are facing similar action locally but their cases are yet to be determined.

## ID.3 from China.

The Volkswagen ID.3 electric hatchback will be built in China, according to the country's Ministry of Industry and Information Technology.

As first reported the Automotive News Europe, SAIC Volkswagen - VW's joint-venture with SAIC Motors - received approval this week from local regulators to begin production at its Anting plant in Shanghai.

The ID.3 was first revealed in September 2019 and is currently built exclusively in Volkswagen's native Germany, at VW's plants in Zwickau and Dresden.

It has yet to be decided where Australian-delivered examples - should they arrive around 2023 as previously suggested - would be sourced from. However a spokesperson for Volkswagen in Australia said: "We're currently exploring all gambits to secure ID prioritisation."



"We hope to bring the hatchback in priced alongside the top of the standard Golf line-up, in the mid-to-high \$40,000 range."

In its standard German-built configuration, the Volkswagen ID.3 sends 150 kW / 310 Nm to the rear wheels via a single axle-mounted motor. Voltage is drawn from a choice of 45 kWh, 58 kWh, or 77 kWh lithium-ion battery packs.

It is not known if the Chinese-built hatchback will differ mechanically or aesthetically from existing variants.

If it does come here, it will be the first Chinese-built VW sold in Australia since the 2004-05 VW Polo Classic (the Polo with a boot).

## Touareg R.

The Volkswagen Touareg R plug-in hybrid performance SUV is coming ever closer to Australian showrooms, with Volkswagen Australia confirming plans are advancing for a local launch for Volkswagen R's flagship model.

Volkswagen Australia has confirmed it is "in discussion" with its German counterpart to bring the 340 kW / 700 Nm, plug-in hybrid (PHEV) Touareg R to Australia,



ever sold in Australia - and there's a chance it (and the improved fuel quality standard due in 2024) could open the gates for more PHEV models to be imported by Volkswagen Group Australia, along with cleaner petrol engines in VW's regular models.

It's a major departure from the last R-badged Volkswagen Touareg sold in Australia, the 2008-10 R50, which sought power from a 5.0-litre twin-turbo diesel V10 good for 258 kW and 850 Nm, and a 6.8-second 0-100km/h sprint time.

## Mini Amarok.

as the fifth Volkswagen R model on sale locally, following the Golf, Tiguan and T-Roc R product onslaught planned for 2022.

While a launch date has yet to be confirmed for the large PHEV, it's understood a local arrival could occur as soon as 2022 (or as late as 2024).

Unveiled in February 2020, the Touareg R was previously ruled out for an Australian launch, owing to poor fuel quality and a lack of emissions regulations, which have seen fuel-efficient plug-in hybrids (PHEVs) prioritised for other markets with such targets - but two recent factors have changed that decision.

"First, the V8 [Touareg] has sold out, and there isn't going to be another one. There is a position at the top of the passenger car and SUV range for a halo vehicle," a Volkswagen Australia spokesman said, noting that the plug-in R's performance, price and capabilities align with those of the outgoing V8.

"[Secondly] the Federal Government recently announced at last that we would have decent petrol ... only 10 years behind Europe, not 13," the spokesman added, noting that Volkswagen Australia was told "you can't have [the R]" by VW's global operation prior to the V8's local success and the fuel quality announcement.

Pricing for the model has yet to be confirmed, though it's understood it will fall closer to the V8 diesel-powered 310TDI R-Line's \$136,490 before on-road costs than the V6 diesel 210TDI R-Line's \$108,990 before on-roads sticker.

Powering the high-performance SUV is a 250 kW/450 Nm 3.0-litre turbocharged V6 petrol engine, paired to a 100 kW/400 Nm electric motor to develop a combined 340 kW and 700 Nm - up 30 kW, but down 200 Nm over the current most powerful Touareg currently offered Down Under, the diesel 310TDI.

Drive is fed to all four wheels through an eight-speed automatic transmission, enabling a 5.1-second sprint from zero to 100km/h.

A 17.9 kWh (gross, or 14.3 kWh net) lithium-ion battery is good for a 47 km range on electric power alone according to Europe's WLTP test cycle, and a combined WLTP fuel economy claim of 2.7 L/100km. A 7.2kW home wallbox can recharge the battery from empty to full in 2.5 hours.

If Volkswagen Australia's talks proceed as desired, the Touareg R would become the first plug-in hybrid Volkswagen

Volkswagen has confirmed it has no plans for a smaller ute sitting below the Amarok, built to rival to the Ford Maverick and Hyundai Santa Cruz car-derived utes - unless it uses all-electric power.

Speaking with industry publication Automotive News, Volkswagen of America sales and marketing boss Duncan Movassaghi said: "Our priority within the Volkswagen brand is to keep our existing [internal combustion-engined] vehicles competitive [and invest in electric vehicles]."

"Investing at this time into a niche ICE [compact ute] segment would not make sense for us."

While a petrol-powered rival to the Maverick and Santa Cruz might not be on the table, an electric dual-cab ute is well under consideration, says Movassaghi: "As we transform our lineup to BEV [battery-electric vehicles], an electric pickup could for sure be an option."

The American executive's remarks come weeks after Ford CEO Jim Farley was reportedly quoted in an interview by The New York Times as saying he "could envision Ford producing a family of Maverick variants, including an electric model."

If such a Ford small pickup does eventuate, it might form the basis of a similar Volkswagen model, in the same way that the Ford Transit will be the base of the next Transporter, and the Ford Ranger will be the next Amarok.



Volkswagen has toyed with the idea of a small or mid-size pick-up in recent years, first with the Amarok-sized (but car-derived) Atlas Tanoak concept at the New York motor show in April 2018, followed by the smaller Tarok concept for the Brazilian market later that year.



## Chinese VW copy.

GWM (Great Wall Motors) sub-brand Ora unveiled a new electric car at the Shanghai motor show earlier this year. The styling is a straight copy of - you know what.

The yet-to-be-named model appears to be considerably longer and wider than the car from which it is derived, as it boasts four doors and a longer wheelbase.

Assuming it rides on the same underpinnings as other vehicles in the Ora line-up - namely the iQ, R1, R2, and Haomao - it will likely be driven by a 35 kW electric motor drawing voltage from a 33 kWh battery pack.

Inside the cabin, the steering wheel and dash look like a US '50s cruiser rather than from the original Beetle. However, a modern digital interface and infotainment system appear to be integrated into the dashboard, alongside turbine-style air conditioning vents.

The Chinese brand is reportedly holding a public survey to designate a name for the retro model. According to (the infamously-imperfect) Google Translate, the available options are 'Elf Cat', 'Punk Cat', 'Noble Cat', 'Persian Cat', 'Royal Cat', and 'Large Orange Cat'. 'Punk Cat' is most likely.

Unfortunately, it appears 'Copy Cat' cannot be selected.

This is not the first time a classic car has been reimagined by a Chinese manufacturer - in fact the Chinese make copies of western vehicles very regularly. Google these names - just a taste - and you'll see what we mean.

Songsan Motors produces a hybrid replica of the 1958 Chevrolet Corvette C1, called the SS Dolphin. Jiangling Motors built a direct rip-off of the Land Rover Evoque, called the Landwind X7. The Zotye SR8 is a clone of the Porsche Macan. The Geely GE is a photocopy of the Rolls



Royce Phantom 7. The Great Wall Gwperi is a carbon copy of the Fiat Panda. The Lifan 320 is a dead ringer for the current BMW Mini. The Songsan Summer is a rip-off of the VW T1 Microbus. The Weikerui V7 is a straight copy of the Volkswagen Up!

## Argo VW fleet.

Volkswagen will begin testing its Argo AI-powered autonomous vehicle service in Germany within the next few months, with a view to launch an autonomous commercial delivery and ride-share service by 2025.



VW will use its own ID.Buzz vans fitted with technology from US-based start-up company Argo AI. Both Volkswagen and Ford back the hardware and software outfit to create autonomous vehicle tech, following the two automakers' global alliance which also includes platform sharing of the next-generation Amarok and Ranger utes.

Argo has been testing its autonomous vehicles within the United States for a number of years now, though this latest development will see Volkswagen deploy fifth-generation tech upon German roads throughout the northern hemisphere summer.

Earlier this year, Argo and VW developed a prototype that used VW's MEB electric vehicle architecture underneath an existing T6 Transporter. It included LIDAR, radar and cameras which allow the AI to 'see' the environment and plan for next steps. According to Argo's founder and CEO Bryan Salesky, this allows for automated driving at low and high speeds.

"We're building our technology and partnering with Volkswagen in a way that really sets us apart from what others are doing," Salesky said. "And we think it really puts us in a position to deliver a safe, smart, and scalable product to deliver on the promise of autonomous driving."

VW intends to put the next-generation autonomous-equipped ID.Buzz vans into its Moia ride-sharing fleet in Hamburg, Germany. To date, Moia has operated a fleet of electric vehicles that has served three million customers. However, the next goal is to develop these rides into an autonomous experience.

It is understood that the Argo tech-equipped ID.Buzz models will operate at Level Four autonomous capability which means drivers will not have to touch the steering wheel, but the vehicles can only operate autonomously under certain conditions. Volkswagen has set itself a goal of bringing these autonomous ID.Buzz ride-share vans by 2025.

# The 5 Volkswagens to be avoided.

We all love our Volkswagens, and I personally think they are the greatest cars ever made.

I am brand loyal and also very biased.

We all need to have something to believe in and I wouldn't like to have to drive anything else.

So I get a little upset when I hear stories, by people, of Volkswagens being unreliable or horrible cars.

As a Volkswagen enthusiast, I take pride in Volkswagen's reputation of having reliable transportation for all of us average Joes.

But let's face it, we can all have a bad day at work, and Volkswagen is no different.

We are all trying to get our cars as cheap as possible and sometimes it can be a fine line for Volkswagen.

Sometimes even they can make mistakes, just like everyone else, believe it or not?

So according to a survey of American VW drivers, if you are looking at complaints from people to Volkswagen, the five worst cars ever, by far are:



- 2002 US Passat
- 2003 US Passat.
- 2006 US Jetta.
- 2006 US Passat.
- 2009 US Jetta.

Even though these are US-made, US-market models not sold in Australia, it doesn't bring me any joy to tell you this.

For some reason, in the USA the Passat and Jetta just seem to make people angry, despite the fact that the US Passat



is built in a spanking new VW factory in Tennessee, and the Mexican-built Jetta is the biggest-selling VW in America.

There are other models on the world market that give Volkswagen a bad name and I'm sure they would buy them back off their owners, if they had enough money.

But they don't have the money, so there you have it, problems if you own one.

At least they are well known for having problems and this might help if you ever have to deal with Volkswagen Australia.

This is the list of 3,880 complaints to Volkswagen, according to US news reports:

Amarok	5
Ameo (India)	1
Arteon	0
Atlas (US)	57
New Beetle	291
New Beetle Cabrio	19
Golf Cabriolet	5
Caddy	1
Caravelle	1
CC	177
Citi Golf (Sth Africa)	5
Cross Fox (Brazil)	2
E Golf (Euro)	2
Eos	76
Eurovan (US)	1
Fox (Sth America)	5
GLI (Mexico)	20
Golf	170
Golf GTI	20
Golf R	1
Golf Sports Wagon (US)	19
GTI (US)	92
Jetta (US)	1,248
Jetta Hybrid (US)	20
Jetta Sports Wagon (US)	48
Microbus	1
Passat (US)	927
Polo	38
Polo GTI	1
Rabbit (US)	34
Routan (US)	162
Scirocco	1
Sharan (Euro)	3

Tiguan	338
Touareg	75
Touareg Hybrid	1
Touran (Euro)	4
Transporter	2
Vanagon (US)	2
Vento	12

Of course you won't find most of these models for sale in Australia. And 3,880 complaints on a production of over 10 million vehicles annually is pretty good. But even so, I hope this helps you the next time you thinking of buying a new or older Volkswagen.

Ashley Day.

## Aisha's Golf Cabriolet.

Hi Ashley,

My name is Aisha and I've been I contact with your Editor regarding my 1997 Volkswagen Golf Cabriolet. He suggested I reach out to you to see if you'd be interested in buying it from me as he said you do them up or wreck them. Mine has a few issues but the main one is the battery is being drained and once stopped has to be jump started. Volkswagen Hamilton had a look and disconnected the immobiliser but it still has been happening and I'm looking for a more reliable car and not looking to fix this one up. A few small cosmetic issues but overall still in good condition and low kms. Would you be interested in it at all? Thanks :) Aisha



To Aisha,

Yes I do love Volkswagen Golfs. In my spare time I like to play with them. I think they are great cars. I have wrecked a lot of them over the years and I have also fixed more than a few.

Golf 3s aren't worth much these days because they are not old enough for vintage rego and not reliable enough for everyday use. So now it becomes a question of: can I hang on to it for seven years until it can go on vintage rego, or sell it to someone else for parts or as a project?



I already have enough Mark 3 golf parts and cars stashed away. But I might have a space for one in good condition, cheap, to keep under cover until vintage rego in 2027.

Cosmetic issues are not a problem. If you could let me know what suburb the car is in, maybe some sort of price and maybe a couple of photos. Thanks heaps Ashley Day.

Oh good to know you have a lot of experience with the model, it currently has rego until Dec 2021. I'll send through some photos. What would you have in mind for the price? I know what I paid but unsure what it would be worth in its current condition.

I have one just like that. I brought it on eBay for \$30. Obviously, it didn't have the Porsche wheels.

It's a great car that would have cost \$50,000 when new, but now?

Everybody knows that I love Golf Cabriolets. They are fun reliable cars. I'm sort of known as the only person that still loves them.

If the car was in Sydney it would be worth \$800 dollars, wholesale.

In Maitland it's worth less if it needs to be towed to Sydney.

Fixed, you might find someone that might pay \$1300-\$1400.

Have you thought about having it fixed? It sounds like a voltage regulator. It would probably need a new battery as well.

I don't think that would cost too much to fix and you could keep using the car for another year. I hope this helps. Great car, thanks for your time.

Ashley Day.

Thanks so much, I might look into getting it fixed if it could be just that part maybe. It's a cool little car and I would like to keep it for a while longer if it would run more reliably haha. Might see if there's an auto electrician or someone in my area that could look at the voltage regulator. Thanks Ashley! Aisha.

# Rack and Roll.

So I'm working on my long-term Beetle project, lavishing all sorts of attention and the best of componentry gifts on it. The subject of the steering box comes into focus. I've had some trouble with VW steering boxes in the past; the one in my Type 3 got really sloppy all of a sudden and the one in my Beetle leaked oil, so I packed it with grease. I never really liked the play which is evident at any angle but the straight ahead and now I'm thinking "there's got to be a way to improve on it".

Rack-and-pinion steering boxes are mechanically simpler, rarely need adjustment and generally outlast the rest of the car. They maintain very little play across the full range of movement. If you can find a suitable rack in a wrecking yard, it's not likely to cost that much. They feel good to drive behind.

VW saw fit to endow the 1975 1303, the L bug in Australia, with rack-and-pinion steering. Then they stopped making the car after only one year, except for Cabrio Beetles which we never saw and which continued to be produced until 1979.

Could this rack be a candidate for a Standard Beetle? No. Like the Passat rack on which it's based, the tie rods connect this rack to steering arms on the front of the struts, so if you were to install it in a Standard Beetle, you would turn left and go right. This means looking elsewhere.

Searching the EMPI catalogue reveals some rack-and-pinion solutions, but they're designed for off-roaders, which need very direct steering response, with a lock-to-lock of only 1.5 turns, compared to the stock 2.6 turns. These items will not do the trick.

OK, what are other people doing? [Kerscher](#) in Germany has a kit for ball-joint or king-and-link-pin Beetles for the very European price of 849 Euro. Left-hand drive only, unfortunately.



LHD rack, bracket and tie rods from Kerscher Tuning

Which car is the donor of this rack, and what's special about the design? VW Polo Mk I or II. The distinguishing features are that it's very narrow overall, the left end of the rack goes along for the ride, protruding into a condom-like cap, and both tie rods attach to the right end of the rack, the shortness of which allows them to sit in the centre of the car.

The vast majority of steering racks are not like this; they are wide and use short tie rods to connect to the steering arms. That's fine for the vehicles they're fitted to, which

generally use MacPherson struts or unequal-length A-arms for their front suspension. In either case, as a front wheel moves into bump or rebound territory, it moves inwards towards the centre of the vehicle. This fits well with the arc described by the tie rods. It's even possible to have zero bump steer with short tie rods on a modern front suspension.

But we're dealing with a design dating back to the 30s: trailing arms, where the wheels move in an elliptical arc forwards rather than inwards on bump and rebound. As a result, bump steer will always be present, so using long tie rods is the only way to minimise its effects. Don't even try to fit a rack to a Standard Beetle if it doesn't look something like the one in the above photo.

A more practical solution comes from Finland. Alex ([alex.storskrubb@gmail.com](mailto:alex.storskrubb@gmail.com)) can supply a complete kit using this same Polo rack. He can supply:

- second-hand racks, including RHD
- a laser-cut rack attachment bracket
- a bracket which moves the tie-rod attachment point from in front to behind the rack and which allows conventional ball-joint tie rods to be used instead of the original heim joints
- modified tie rods
- rack attachment clamps

for a considerably lower price than the Germany-sourced solution, but still quite substantial. You would need to weld the bracket into place onto the Beetle's frame head, shorten the steering column and supply a U-joint from a Polo, Superbug or similar. I've been in contact with Alex and he has shipped a few kits to Australia. I would happily steer you towards him.

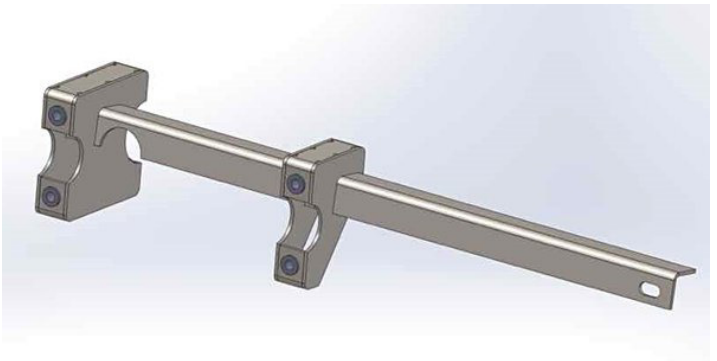

Alex's LHD rack bracket

Trouble is, Polo Mk I and IIs are getting a bit long in the tooth (that's a steering-rack joke attempt). RHD Polos of the era were only delivered to the British Isles, as far as I know. LHD racks are still being made and remanufactured, but not the RHD ones. The ideal solution would be to find a rack which meets the prerequisites described above, which is available locally, cheaply and in good condition. Not forgetting that I live in Malaysia, it would be nice if the chosen donor car was sold in Australia as well.

After lots of image searches sifting through photos of conventional long racks with tie rods dangling off both ends, I managed to stumble across a few which resemble the Polo rack. Here's the short list:

- Peugeot 106 / Citroën Saxo
- Honda Civic seventh generation, 2000 - 2005
- Opel Astra F or G, 1991 - 2004
- Porsche 914

I've come across a reference from a UK forum of Citroën Saxo racks being very similar to the Polo item and of someone fitting one to a Beetle. I don't think either the Saxo or the 106 were sold in Australia.

The Honda rack should be easily available anywhere. No evidence yet of anybody fitting one to a Beetle. Its suitability remains to be seen.

The Opel Astra F was sold in Malaysia, though they're a bit rare. The Astra G was sold in Oz. The same rack was fitted to Daewoos and some Holden Camiras. I've seen a discussion of a Camira rack being fitted to a T2 Kombi.

The Porsche 914 option appeals to me because of familial connections, and they're centre-mounted in the car, so there's only one part for left and right-hand-drive cars, but they're not thick on the ground in these parts. You can get them from the States via eBay, second hand, for around \$US200. Second-hand means a part which was new 50 years ago ...

With any conversion like this, there are things to watch out for. Some cars, like the Polo and Peugeot/Citroën, had a non-power-assisted variant. These are the ones to go for, but if there's no other option, any parts related to power assistance can be safely removed without affecting the operation of the rest. The power-assisted racks in the 106 and Saxo actually used an electric pump, so there's an idea ...

When fitting the Polo rack, there is room for fitting the stock steering damper, though people who have done the conversion say it's not necessary.

Clearance to the fuel tank is an issue. Alex's kit is dimensioned to fit with no tank mods. Other people speak of having to create clearance using a Fairly Big Hammer. Others make a spacer bracket to lift the whole tank. Cutting/welding a used tank is not on; I speak from painful experience. If I need to do such reshaping, the operations will be performed on a brand-new tank.

Inherent in the shape of any rack bracket, whether it's a bought one or one you're going to design yourself, is the steering geometry. The inner tie-rod pivot points need to be centred. They should be at the same level as the outer ends, preferably adjustable through shims to take into account the variable nature of owners' ride-height settings. As the body is lowered, the rack needs to rise, so it gets more in the way of the fuel tank. The distance between the back of the torsion-bar tubes and the tie-rod ends should be the same as stock, in order to preserve correct Ackerman angles, which translate to toe out on turns.

The final choice of the rack-to-be-used is going to be down to hours spent perusing wrecking yards, something not possible at the moment, as the government for some reason doesn't consider them to be an essential industry. You will read a follow-up in a future "Project of My Life" article.

Rod Young  
[rod.young2@icloud.com](mailto:rod.young2@icloud.com)



## Chris Vallone VW.

Sharing some info re the latest you tube video from Chris Vallone. This 1957 oval factory rag top bug pictured just sold at Gooding@ Company Auction for US\$90,000 plus a 10% buyer's premium.

Up and Up they go! See attached pics.



In case you don't know him, Chris Vallone was born and raised in Rockland County NY, and his passion is classic VWs.

Beetles came into his life back in summer 1999. He bought a '71 Super Beetle Cabrio on impulse. But it wasn't until he bought a rusty '68 sedan in 2002 where for the first time he went through a full resto on a bug. From there he found a great new hobby of finding VWs and restoring them back to their historical beauty.

Chris has now combined his film making skills and his VW hobby into a full-fledged business, working with his father full-time.

Chris Vallone has inspired tens of thousands of people with his creative yet down to earth style. He has generated a Global Following with his Vintage Classic VW Bug restorations and his "How to Restoration Video tips" on the web. He earns his living from the Internet and he works full-time restoring VWs & educating others how to restore/repair their own.

Chris has won numerous awards with his restored VWs at many US VW shows. He has appeared on Fox News, USA Today and been featured in HotVWs magazine, Air-Cooled Classics magazine, VolksWorld and VolksAmerica.

He even worked on comedian Jerry Seinfeld's 1956 Oval Window Bug in January of 2013.

Visit his website at [www.classicvwbugs.com](http://www.classicvwbugs.com) or do a Youtube search on 'Chris Vallone VW'. He has his own YouTube channel called 'brighteyefilms.'

Cheers,

Carl Moll



The controls have all been reworked to be touch capacitive (we'll talk more about those later), and other signature GTI elements are standard, like the flat-bottomed, leather-bound steering wheel, and tartan seat trim.

Luxuries include fully keyless proximity unlocking, push-start ignition, tri-zone climate control, and a comprehensive safety suite (even more so than the outgoing 7.5) which we'll take a closer look at later.

The GTI can be chosen in a unique colour from the rest of the range - Kings Red - which comes at an additional charge of \$300, and there are two option packs. The most expensive of these is the

Luxury package, which wears a \$3800 cost and adds partial leather interior trim, heated and ventilated front seats with power adjust for the driver, and a panoramic sunroof.

The Sound and Vision package comes in at \$1500 and adds a nine-speaker Harmon Kardon audio system, and a holographic head-up display.

#### Is there anything interesting about its design?

The GTI is the most significantly visually overhauled variant in the Golf 8 range, bringing with it not just the refined LED lighting profile, but adding a highlight strip all the way across the car's nose, and DRL clusters in the lower bumper. This grants the GTI a menacing, distinctive profile, particularly when spotted at night.

From the side, the GTI sets itself apart with the lower ride height and more aggressively shaped bumpers, while distinct alloy wheels finish a chunky, appealing box.

Round the rear, and the iconic hatch profile is completed by a dual exhaust and new 'GTI' lettering across the tailgate. It's contemporary, fresh, yet iconically Volkswagen. Fans will love it.

The inside is where the biggest changes take place. The GTI's interior is largely the same as the main range, with its full-on digital overhaul. The screens will dazzle you from the driver's seat, while the GTI's familiar low-set driving

## Golf 8 GTI.

The GTI badge has been in existence almost as long as the venerable Volkswagen Golf itself, having first appeared in Germany in 1976 as a 'skunkworks' project. It was first made in RHD for the UK market from 1979, but never made it to Australia. We didn't see the GTI until 1990, in out-dated 8V Mk2 form, and we missed the Mk3 version too (although we did get the VR6). But since the 1999 Mk4 GTI, it has been a staple of the Australian line-up. The iconic VW Golf performance variant has managed to outlive countless rivals to become inseparable from the phrase 'hot hatch.'

Now in its Mk 8 form, the GTI itself has long since been usurped by faster, more powerful AWD hatchbacks - like the Golf R and Mercedes-AMG A45 - becoming instead the more approachable sporty example in Volkswagen's range.

After all these years, has it faded to become a shadow of its former self, or should it still be the default choice for anyone wanting a taste of power without spending serious performance money? We've taken the new one for a spin, both on and off the track, to find out.

#### Does it represent good value for the price? What features does it come with?

First things first, the Golf GTI is more expensive than ever. Now wearing an RRP of \$53,100, it's impossible to call the GTI 'cheap', even for the relative performance on offer.

For example, it's still more expensive than the more powerful (but cruder) Hyundai i30 N Performance, which in automatic guise wears a price-tag of \$47,500, and more expensive than the Ford Focus ST (torque converter auto - \$44,890), and about on-par with the more enthusiast-focused Civic Type R (manual only - \$54,990).

To be fair, the GTI has taken a significant hike in standard features, too. It gains the full digital overhaul from the rest of the Golf range, including the very good 26-cm digital instrument cluster, 25.5-cm multimedia touchscreen, complete with wireless Apple CarPlay and Android auto connectivity, wireless charging, and built-in sat-nav.



position, cosy seats, and blacked out interior features set it apart.

There are other interior highlights that the rest of the range can't match, too, like the tartan seat trim on non-luxury-package-equipped examples, a patterned highlight strip across the dash, and a clasping mechanism for your phone over the wireless-charging bay, to ensure it doesn't make a swift exit during more inspired bursts of driving.

Smart, refined, heavily digitised. The GTI's cabin is the future you've been waiting for, although it does, perhaps, go a little too far in a few places, which we'll look at in the practicality segment.



### How practical is the space inside?

The main downside to the GTI's new interior layout is the lack of tactile dials and buttons. These have been replaced entirely by touch-capacitive interaction points. I'll give full credit to the brand, these slider bars and touch buttons are executed in a better fashion than pretty much all of its rivals, but there's still no replacing a physical dial for climate or volume functions, particularly when you're enjoying this car's performance virtues, and are keeping your eyes on the road.

The clasp for your phone is an inspired addition for the GTI, and elsewhere the cabin is as smart as it is in the rest of the range. This includes huge pockets in the doors, a large centre console cutaway with a fold-out cup-holder mechanism, a decently sized centre console armrest box with a variable height mechanism, and a glovebox.

The rear seat is just as good as it is in the rest of the Mk 8 range, with surprising room on offer for adult-sized rear occupants. The chunky sports seats do take a little away from knee room, but it's plenty adequate, as are arm, head, and foot room. Rear passengers are also treated to excellent seat trim, three alternately sized pockets on the backs of the front seats, their very own climate zone with adjustable air vents, a drop-down armrest with three cup-holders, large door pockets, and dual-USB-C outlets. This grants the GTI one of the best back seats in the class, if not the best, in terms of amenities and space.

Boot space is unchanged from the rest of the Mk 8 range at 374-litres (VDA), which is not at the top of the segment, but certainly better than many, and there remains a space-saver spare wheel under the floor.

### What are the key stats for the engine and transmission?

Those who were looking forward to some major changes for the eighth-gen GTI may be disappointed here. The new car carries over the same engine and transmission from the Mk 7.5. This consists of the highly regarded (EA888) 2.0-litre four-cylinder turbo petrol unit, continuing to produce 180 kW/370 Nm, which drives the front wheels via a seven-speed dual-clutch automatic.

This isn't to say the Mark 8 GTI hasn't been improved in other significant areas. VW has tweaked the front subframe and suspension to add lightness, and added a tweaked 'XDL' version of its electromechanical limited-slip differential to improve handling and performance. Adding to this, the GTI has adaptive dampers as standard.

### How much fuel does it consume?

The GTI has an official/combined fuel-consumption number of 7.0 L/100 km. This is about right for a performance 2.0-litre engine in this class, although it is a fair bit higher than the consumption number of the regular Golf 8 range.

The GTI requires mid-shelf 95RON unleaded fuel and has a 50-litre fuel tank. Our time testing the car produced a computer-reported 8.0 L/100 km, although you can expect this to vary greatly depending on how you drive it.

### What safety equipment is fitted? What safety rating?

The GTI gets the same comprehensive safety coverage as the rest of the Golf 8 range. This includes a particularly impressive active suite, which offers freeway-speed auto emergency braking with pedestrian and cyclist detection, lane-keep assist with lane-departure warning, blind-spot monitoring with rear cross traffic alert, safe-exit warning, driver-attention alert, and adaptive cruise control with stop-and-go function.

The range also scores an additional airbag for a total of eight, and now also has an emergency SOS function. Like other new VW group models, the Golf eight range also has a 'proactive passenger protection system', which tightens the seatbelts, fixes the windows for optimal airbag deployment, and applies the brakes in preparation for secondary collisions.

The rear outboard seats have ISOFIX child-seat mounting points, while there is a total of three top-tethers across the second row.





Somewhat unsurprisingly, the entire Golf 8 range is covered by a maximum five-star ANCAP safety rating to the 2019 ratings standards.

#### What does it cost to own? What warranty is offered?

Like the rest of the range, the GTI is covered by Volkswagen's competitive five-year and unlimited-kilometre warranty, complete with roadside assist. The ownership promise is improved by choosing the pre-paid service plans, which have the added benefit of being able to be added in on finance at the time of purchase.

Three years of servicing on the GTI comes in at \$1450 using this method, while five years (claimed to be the best value) is \$2300. These are a slight hike on the rest of the Golf 8 range, to go with the GTI's more complex transmission, and while the pricing per-year is more than some rivals, it's not outrageous.

Where could VW do better here? Hyundai offers a track warranty with its range of N performance models, something which VW tells us it is not interested in at this time.

#### What's it like to drive?

The GTI is everything you'd expect it to be, and more. This is because the EA888 engine and seven-speed dual-clutch transmission are a tried and tested combination, which have performed well in this car's previous iteration.

It's safe to say that if you've driven or owned a GTI in the recent past, this will largely be the same in terms of its dynamics and performance, both on the track and on the road.

The seven-speed dual-clutch combines much more nicely with a higher-torque engine to eliminate the kinds of low-speed stresses we normally complain about in lesser



models, while its lightning-fast shifts and instantly responsive paddles make it the automatic transmission of choice for track drivers.

It's a shame there's no manual transmission, sure, but Hyundai only offers an eight-speed dual clutch on its latest iteration of the i30N, too.

Where this new GTI really shines, though, is its improved front-end. The lighter subframe and suspension components combine with the new limited-slip differential for some serious handling magic. Anyone who has driven a hot hatch with an added front differential will know what I'm talking about here. It's positively transformative to the way the car deals with corners, preventing understeer, enhancing grip, and allowing for more control when powering out.

For the track this ultimately means much faster cornering and more trim lap times, without having to add additional power, but on the road this also means you'll get some measure of the predictability and safety that is otherwise only offered on all-wheel drive hatches, like the Golf R or Mercedes-AMG A45.



Elsewhere, the GTI is able to outstrip even its more enthusiast-focused rivals by combining the aforementioned items with an adaptive-damper tune that offers the kind of body control that removes the more unpleasant parts of cornering in a front-driver. For example, the GTI will lock things down and maintain traction, even when pushed toward its limits, compared to the i30N, which will body-roll into a corner and start to stutter on the outside when pushed to the same extremes.

It's a sophisticated package, and while it might not be setting the kinds of lap times laid down by the Rs and AMGs of this new, much higher benchmarked hatch world, it's simply a pleasure to enjoy a one-off track day or curvy B-road in, even if this GTI is no longer out-punching rivals on the power front.

Ultimately, then, this car finds its niche, even at the price asked. Spending less will get you the fun but wiley Focus ST, or perhaps the less techy but more gear-headed i30N or Civic Type R. Either way, I know which car I'd rather drive home in on suburban roads at the end of a track day, making the GTI the ideal offering for the more common but less vocal casual enthusiast.

On a final note, the GTI does come with a handful of expected downsides for the suburban driver. The steering is heavier than the standard Golf range and the ride can be



sharp, especially with the large wheels and lightened front-end. Road noise at freeway speeds is also a bit intrusive.

This is a small price to pay for the performance and cabin comfort on offer, I'd argue.

### Verdict

The Golf GTI continues to be the iconic hot hatch it has always been, and while it is missing an engine and transmission overhaul, it still manages to take everything it is good at and improve on its tried and tested formula, even if only a little this time around.

I'm confident existing fans and casual enthusiasts not needing or wanting to fork out for the pinnacle of performance offered by something like the Golf R will love this new GTI iteration, which is just as much fun around town as it is on the track.

Tom White

## The VW Auto 2000.

*Wheels magazine, January 1982*

Imagine arriving at a 100 km/h corner, hoping to negotiate it accurately with clutch disengaged and the engine off.

It might sound like a recipe for disaster in your bucolic old Cortina six, and it is - but it's also something for which a new Volkswagen research vehicle is purpose built.

I recently took a trip to Wolfsburg, the gigantic VW works, to drive VW Auto 2000, a research vehicle shown at the recent Frankfurt Show. The car I drove had a three-cylinder diesel engine of 1.2 litres (the four-cylinder diesel with the block cast alloy, a 120 deg crankshaft and one cylinder surgically removed) which has been proven in tough government testing over there to be capable of averaging 4.0 L/100 km (70.6 mpg).



Most of the secret of the car's performance is that its engine switches off when not needed for power - such as when the car is being slowed to negotiate a corner. The drivetrain layout is broadly speaking conventional Golf (as is the floorpan). But there are two electronically controlled clutches, one between engine and flywheel, the other between flywheel and transmission.

When you get into the car to drive it, you don't actuate a conventional starter motor but a motor which rotates the



flywheel which is declutched from both engine and gearbox.

There's a whirr as the flywheel rotates but no conventional ruh-ruh-ruh. You press lightly on the throttle and the electronics (there's a central engine-governing microprocessor) closes the engine-to-flywheel clutch gently and turns on the fuel.

Suddenly, the engine starts without a jump or judder. You press a little harder on the throttle pedal, the engine revs rise to around 1000 and the electronics gently close the second clutch and (provided you've selected first in the conventional five-speed gearbox) the car starts to move. For gear changes there's a clutch release that works when you touch the lever knob (ala NSU R080 and VW Beetle semi-auto). On the over-run, the clutches both open, the fuel is cut, the engine stops and the car coasts serenely with nothing but a bit of road noise and a far-away whir from the flywheel to disturb your concentration. You can even hear yourself breathing.

As pictures suggest, the car has particularly good aerodynamics and these help in two ways. They allow the car to coast a long way so that it needs amazingly little help from the engine to maintain, say, an 80 km/h cruise. They also cut the wind noise literally to nothing. The Cd of the road-ready prototype is 0.25 which is impressive enough but its frontal area is small, too, so that the all-important CdA is only a little more than half of the average set for cars of the Golf class.



(The VW Auto 2000 prototype can be seen today in the Wolfsburg Museum - Ed.)



Mike Drewer hopes to one day get his 1964 VW Beetle up to 320 kilometres per hour. (Facebook: Mike Drewer)

## VW Salt Race Car.

Is it Australia's fastest Beetle?

I don't know.

I also can't claim it to be a VW thoroughbred, given the insertion of a Subaru WRX turbo motor and gearbox. But I do know that it still looks like a Beetle, drives like a Beetle and has oodles of Beetle DNA and character.

My fascination with the VW marque goes back to boyhood. My father drove a brand new big back window model when they were first released, and he had two 'splittie' VW service vans in his business. My son raced a Formula Vee.

So what do in retirement but to build a VW Beetle based land speed record car and compete at the annual DLRA Speed Week held on the salt at South Australia's Lake Gairdner, a venue said to be the equal or better than the USA's famous Bonneville event.

There wasn't a blueprint or design for such a car, so I read plenty about the salt racing car world and started to build my VW.

I acquired a fairly ratty body shell, a very good pan, and a couple of other rusty VW's that had been partially parted out.

First was the extreme five inch roof chop, which confirmed that the complex shape of a Beetle makes it a difficult car to chop. Doors of course also

had to be chopped, but at least glass wasn't a problem given the fact that we used Lexan all round.

A very robust roll cage as required by DLRA land speed racing regulations was constructed on the pan, the rear suspension was converted from swing axle to double-joint, and the wheelbase was extended by reversing the arms on the H-beam.

Remember this is a straight line only machine, so the steering geometry wasn't important other than to introduce plenty of self-centring by laying the H-beam back to increase castor.

I also run toe in both front and rear for additional straight line stability and zero camber.

The car uses coil overs both front

and rear in place of the torsion bars.

The 4-cam Subaru engine produces over 300bhp at the rear wheels and runs a water barrel intercooler fed ice water circulated through an 'Esky' located in the passenger seat area.

The radiator is horizontal in the old fuel tank position, with a custom 20 litre aluminium tank for E85 positioned just behind the instrument panel area.

We use original VW wheels mounted on after-market VW disc brake hubs and rotors with studs rather than wheel bolts, and special Goodyear salt race tyres at the rear and M&H drag race tyres at the front.



It's a strange car to drive. There is little traction on the salt. It's like driving on wet smooth cement or perhaps a good dirt road with a floating surface.

We all know that front end stability wasn't the forte of the Beetle so the car has plenty of ballast and I have also added a front 'splitter' and rear spoiler.

Weight is not an issue for a land speed record given you have seven miles to get up to speed on the long course.

So what about the speed?

Well, it has been to Lake Gairdner on three occasions. First time in 2018 we ran 134 mph (215.7 km/h). Received Rookie of the Year Award.

In 2019 we ran 148 mph (238.3 km/h).



asked me to looking into see if these items could be in a museum or somewhere for display showing the history of the person who helped bring Volkswagen into Australia.

If you could point me in the right direction your time would be most kindly taken.

Thank you kindly

Michael Challis

Hi Michael, thanks for your message (above), left on the Club VW Sydney webpage.

It sounds like you have some amazing things there. Yes, LNC Industries was originally

the NSW distributor for Volkswagen from the earliest days, and they set up Lanock Motors as their VW dealership chain. From 1968, after the Melbourne-based Volkswagen Australasia Ltd ended local manufacture and was liquidated, LNC was awarded the VW distribution rights for all of Australia. They then set up a new LNC division called Volkswagen Australia Ltd - an unusual instance of an independent company owning a division with the 'Volkswagen' corporate name.

Initially Volkswagen Australia was based at Lanock Motors' head office on William St in Sydney, but in 1971 LNC built a new VW admin and parts head office at North Ryde. By this time LNC was a conglomerate of other auto businesses apart from VW, including Rover, Jeep, Colt/Bellett, Rambler and Dodge trucks. Later they also distributed Subaru, Fiat, Renault, Lancia and Audi. At the same time, LNC's corporate head office was moved to the BMA Tower on the Pacific Hwy at Chatswood - that iconic '60s office building with the lift on the outside.

Doug Donaldson began as a salesman for Lanock Motors in the mid-'50s and quickly rose to become the sales manager for Lanock Motors, then the head of Volkswagen Australia, and head of LNC Industries. He also served as the chairman of the Federal Chamber of Auto Industries a number of times. He was one of the most respected bosses in the Australian motor industry.

While LNC gradually closed down the VW-Audi business in the late '70s and early '80s, their other businesses, especially Subaru and Honda, kept the company profitable. Doug Donaldson retired through ill health in 1986, and LNC Industries was taken over by the Liberman Group who broke them up and sold off their assets. LNC lost the VW-Audi franchise in 1987, picked up by Ateco Industries and later TKM/Inchcape. By 1990 LNC no longer existed. Doug Donaldson died of emphysema in 1991. I was at the 'wake' function for Lanock Motors when they closed down in 1992, bought by the City Ford group of companies; I remember Doug Donaldson's widow Lee was in attendance.

There is no VW museum in Australia as such, but it would be good to see your items preserved. Today's Volkswagen Australia company at Chullora (founded in 2001) does have a small collection of historic items, including some classic cars, some old films and documentation - even the Wheels Magazine COTY award trophies that LNC won for the Passat in 1974 and Golf in 1976. These were in a glass case in the foyer last time I was there. I think VW Australia would be the best place to donate these items.

Why not contact either VW's Australian boss Michael Bartsch, or their PR boss Paul Pottinger? Their number at Chullora is (02) 9695 6000. I am sure they would be accommodating, and look after the historic items with proper respect and care.

Let us know how you go - it would make a great story for our magazine! We would also love to hear more stories from the Donaldson family, if you know them, as they are one of the most important parts of the VW story in Australia and I think it would be wonderful to preserve what information they have for posterity.

Event was not held in 2020 because of COVID.

The latest run happened this year, in March 2021. We did 160.4 mph at the 3-mile mark before I backed off! That's 258.2 km/h.

Date	09/03/21
Time	14:42
Run #	2
LOCATION	SPEED (mph)
2 1/4 Mile	158.730
3 Mile	160.401
4 Mile	0.000
5 Mile	0.000
5 Mile Exit	0.000
6 Mile	0.000
Wind: 13.0 mph	from SE

There is more to go, but I now have to fit a parachute and get an upgraded medical check given my age of 74 and a heart attack in the recent past.

By the way, if you know of a faster Beetle I would love to hear about it.

Mike Drewer

(Article submitted by Carl Moll)

## Klub Korrespondenz.

From: Michael Challis

Date: 25/07/2021 13:58:25

I am just inquiring about LNC Industries Limited. I have some memorabilia of the company in the old days from a former well known leader of the company that being a gold Omega watch with the LNC Industries Limited and Doug Donaldson 25 years of service 1979 and a Volkswagen pocket knife. Family members have

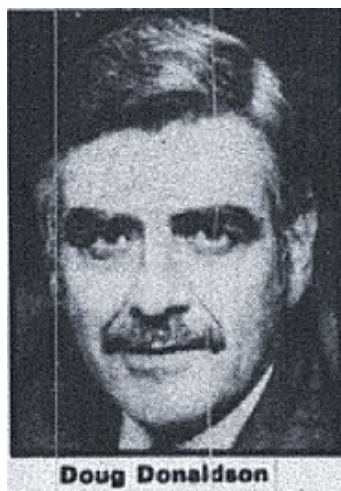

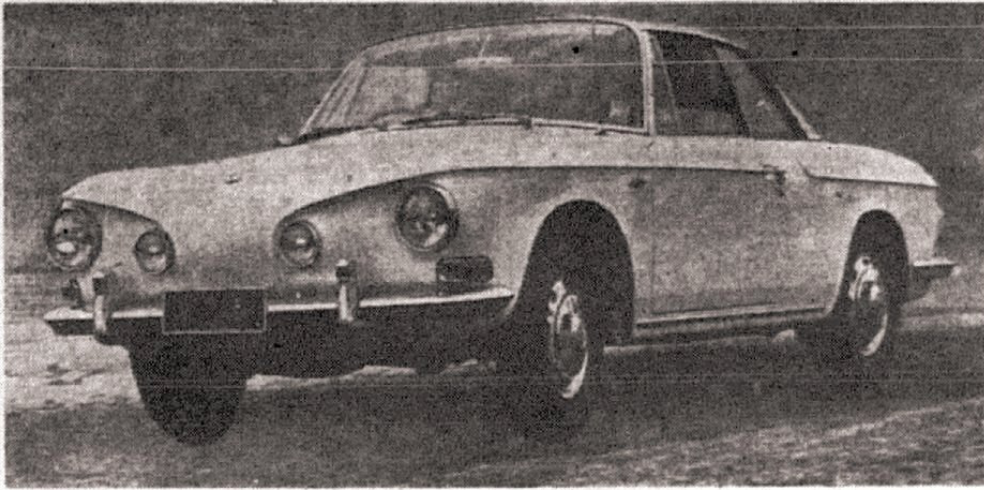

## The VW Karmann Ghia 1600.

*The Sydney Morning Herald, Monday 19 December 1966*

The Volkswagen Karmann Ghia combines the skills of two of the world's top motor manufacturing nations.

A beautifully styled and executed body, from the drawing board of Italian designer Ghia and built by the German Karmann concern, adorns a German Volkswagen chassis and power unit.

The result is very pleasant motoring - an exercise in international industrial cooperation.

It seems a pity, then, that the Karmann Ghia is priced well above its class in Australia.

While its obvious quality cannot be doubted there is just not enough of the car to warrant a price tag of \$3,990, more than twice the cost of a normal VW 1300 sedan.

Volkswagen Australasia puts the blame on the high cost of importing the cars in a fully built-up condition into Australia, and the extra taxes that therefore apply.

However the company says that it is at present conducting negotiations in an effort to alleviate the situation.

I, personally, hope they succeed. It would be a shame if this car went the way of most other 'specials.'

Along with the flat-four air-cooled engine in the rear, part of the VW formula for success has always been a very high 'overdrive' top gear for tireless cruising. Because of this high gearing, even moderate main road gradients required a quick change down to third.

The advent of the 1600 power unit, developing 65 bhp has changed this. Providing one is travelling at a reasonable speed, the car will negotiate most hills in top without flagging.

Not to say that gear changing is a chore. The box is light and positive in action and is endowed with synchromesh, even on first gear, as close to perfection as I have yet experienced.

On first entering the Karmann Ghia, I found the offset of the pedals to the right a little disconcerting. No matter where the driver's seat was placed, either the accelerator felt too close or the clutch too far away.

However after a short spell behind the wheel, one becomes accustomed to this. Not so the action of the pedals. Both the brake and clutch are hinged from the floor, and

because of their action it is necessary to lift one's foot to operate them properly.

Also, the offset of the pedals means that the clutch is hard up against the central tunnel, so that there is nowhere to rest the left foot when it is not actually engaged.

Another point I discovered quite accidentally is that it is possible for the passenger to unwittingly jam the throttle open, with obvious dangerous consequences. The accelerator linkage evidently extends beneath the carpeting on the passenger-side firewall. By pressing his, or her, foot

in the right place on the floor - as could easily happen in an emergency situation - the passenger is capable of holding the throttle open regardless of the efforts of the driver.

### How it goes

With the bulk of its weight concentrated over the rear wheels, the Karmann Ghia naturally oversteers and this can be used to advantage by an experienced driver.

On bitumen the tail breaks out quite gently, allowing plenty of time to correct with the light, direct steering which transmits plenty of 'feel' to the driver along with some road shock.

The combination of big wheels and well-balanced torsion bar springing gives a superb ride regardless of the state of the road surface. The car stayed glued to the road when driven hard over wheelbase-long undulations and potholes or corrugations could be treated with contempt.

The car remained absolutely rattle-free during the test - a tribute to the care of its constructors.

There is no noticeable body roll when cornering.

Although I would not describe it as powerful, the Karmann Ghia seems a lot peppier than the acceleration figures indicate.

The end of the standing quarter-mile was reached in a

**READ ABOUT IT!  
THEN TRY IT!  
SEE US TODAY  
WON'T DO BETTER  
McCALLUM MOTORS PTY. LTD.**

**VOLKSWAGEN AGENTS**  
Cnr. Parramatta Rd. and Concord Rd.,  
STRATHFIELD.

**74-1286**

moderate 20.8 seconds, and sprinting from 0-80 km/h took 14.5 secs.

Acceleration times in gears were:

Top

20 to 40 mph (32-64 km/h) - not done  
30 to 50 mph (48-80 km/h) - 16.9 sec  
40 to 60 mph (64-97 km/h) - 17.5 sec

Third

20 to 40 mph - 10.3 sec  
30 to 50 mph - 8.5 sec  
40 to 60 mph - 11.6 sec

The relatively good time of 58.5 sec for a lap of the 1¼-mile (2 km) test circuit shows that the car can perform well when wound up.

Exactly 38 mph (61 km/h) was showing on the speedo when the car reached the crest of the test hill in top gear. The speed had dropped to 30 mph (48 km/h) at the end of the steepest section.

The test fuel consumption of 24.4 mpg (11.6 L/100 km) shows that the Karmann Ghia should yield an economical 30 to 35 mpg (8.0 to 9.4 L/100 km) under normal use.

When cruising with the windows closed, the car is exceptionally quiet with no suggestion of wind or road noise. Only a reassuring hum comes from the motor and the optional radio fitted to the test car could be heard quite clearly when travelling at top speed.

### How it stops

Even though the front disc, rear drum braking system is not power-assisted, the pedal pressures required are only moderate. The brakes are well balanced and pull the car up in a straight line without any sign of wheel locking.

From 30 mph (48 km/h) the car stopped in 29 feet (8.8 m), and from 60 mph (97 km/h) in 135 feet (41.1 m). Both these figures are very good.

Repeated heavy applications on a downhill run produced only slight fade, with extra pressure bringing back full stopping power. Recovery was rapid.

It is possible to lock the rear wheels at 30 mph (48 km/h) on level bitumen without having to exert too much effort on the conveniently placed handbrake lever.

### What's inside

The Karmann Ghia is intended mainly as a two-seater coupe, or as one observer quipped: "For a couple with two legless children."

The rear padded bench is obviously meant only for emergency use and two adults could cram themselves into the restricted space if the front seats were positioned well forward.

As well as being adjustable fore and aft, the front bucket seats can also be varied for rake.



## BUYING VOLKSWAGEN?

*Then phone Lennox now for a test drive and valuation*

EASY TERMS — LOW DEPOSIT AND N.R.M.A. INSURANCE

NEW ● 1600 (Fastback) SEDAN

● 1300 SEDAN

## LENNOX MOTORS

PTY. LTD.

*Western Metropolitan's Largest Dealer*

● Cnr. Smith & George Sts., Parramatta  
635-5844.

● Cnr. Church & Junction Sts.,  
GRANVILLE  
637-1849 (OPEN ALL WEEKEND).

● MAIN ST., BLACKTOWN  
622-1293

These seats are firmly sprung but very comfortable and provide adequate lateral support.

Black vinyl with perforated sections is used to cover the upholstery. This is very fashionable, but I have found that seats in this colour become unbearably hot when the car is left standing in the summer sun for any length of time.

The car is fitted as standard with sash-type safety belts in the front compartment, and there are mounting points for lap belts in the rear.

Other concessions to safety include a soft padded strip along the top and bottom of the pressed metal fascia; crushable sun visors, an outrigger mirror on the driver's door to supplement the adequate rear vision mirror, windscreen washers and built-in twin fog lights.

The rather rudimentary instruments are confined to three dials located directly in front of the driver. They include an accurate though sparsely calibrated speedo, a fuel gauge and lights for high-beam, low beam, oil pressure and amperes. There are also indicator lights for the blinkers.

The hardtop construction of the cabin gives the driver excellent all-round vision. Care has also been taken to eliminate glare from the wiper blades,

which have a matt finish.

The steering lock / ignition switch is mounted a little awkwardly on the steering column. With the switch on the 'lock' position, any attempt to turn the steering wheel operates the twin horns. I imagine this would be quite discouraging to any potential thief.

Two unmarked levers in the centre of the fascia control fresh air vents and the heater-demister controls are situated on the centre floor hump.

The front quarter lights (windows) are fitted with small drip-catching troughs for rainy weather and the rear side windows hinge from their forward edges to allow a through-cabin flow of air when opened.

Small articles could be stowed in the lockable fascia glovebox or in the map pockets on each door.

Opening the rear 'boot' lid reveals a very shallow, lighted compartment, probably only adequate for a couple of briefcases. The floor of this compartment lifts up to allow reasonable access to the engine.

There is a larger, though still quite shallow, stowage area beneath the front bonnet. This compartment also takes the spare tyre, mounted at an angle to the nose, and the nominal tool kit.

Folding the squab of the rear bench seat down leaves a flat carpeted area suitable for cases or other travelling paraphernalia.

The test car was provided by Volkswagen (Distributors) Pty Ltd, the distributor.

**Details at a glance:**

**PRICE:** Fully imported, \$3,990

**PERFORMANCE:** Maximum speeds in gears: Top, 95 mph (153 km/h); third, 75 mph (121 km/h); second, 47 mph (76 km/h). Standing quarter-mile (400 m), 20.8 secs. 0-50 mph (80 km/h), 14.5 secs. 0-60-0 mph (97 km/h), 22.6 sec. Normal fuel consumption, 30-35 mpg (8.1 to 9.4 L/100 km).

**ENGINE:** Flat four of 1584 cc, developing 65 bhp (SAE) at 4600 rpm and 87 lb/ft (114 Nm) at 2800 rpm. Bore, 85.5 mm; stroke, 69 mm. Compression ratio, 7.5 to 1. Twin downdraught Solex carburettors, oil bath air cleaner.

**GEARBOX:** Four-speed, floor change, all synchromesh.

**BODY:** Two-door, two-seater, reasonable luggage capacity. Separate platform and backbone chassis. Heater-demister.

**BRAKES:** Front discs, rear drums. Lining area 82.2 sq. in (530 cm<sup>2</sup>). Pedal pressure for 0.5G stop from 60 mph (97 km/h), 50lb (22.7 kg).

**STEERING:** Worm and roller type with 3.5 turns lock to lock. Turning circle, 35ft (10.7 m).

**SUSPENSION:** Independent torsion bars front and rear. Anti-roll bar at front.

**DIMENSIONS:** Wheelbase, 7ft 10.5in (2400 mm); length, 14ft 0.5in (4280 mm); tracks, 51.6 and 53.0 in (1311 and 1346 mm); clearance, 5.4in (137 mm); tyres, 6.00 x 15in; petrol tank, 8.8 gals (40 L); weight, 17.8 cwt (905 kg).

By Barry Seton, as told to the Motoring Editor

## Antarctica 1 film.

Most of us are familiar with the story of 'Antarctica 1,' the 1962½ Volkswagen 1200 that spent a year at Australia's base at Mawson. The story has been told many times in books and magazines over the years, including in Zeitschrift a number of times. The definitive and most detailed story is on our website, at [www.clubvw.org.au/vwreference/antarctic-vws/](http://www.clubvw.org.au/vwreference/antarctic-vws/) Our page has been used as a reference by many other writers and publishers, and we receive feedback from all over the world.

Apart from the basic car donated to ANARE by Volkswagen Australasia Ltd (and chosen from the Clayton production line in late 1962 by the incoming 1963 ANARE expedition leader Ray McMahan), VWA also performed the winterisation of the car prior its departure. VWA fitted numerous accessories such as extra gauges, roof rack, vent cover, second battery, winter tyres and tow bar. VWA also donated a generous box of general spare parts and spare



wheels. Significantly, included among the spares was a quality Bolex cine camera and a generous stock of movie film.

The camera and film stock was used by official ANARE expedition photographer Geoff Merrill. He shot 16mm film footage of the car as prepared; then he filmed the loading of the VW on board the MV Nella Dan at Port Melbourne and the voyage south. Dr Phillip Law (1912-2010), the eminent Australian Antarctic adventurer, long-time leader of ANARE and founder of Australian bases at Mawson, Davis and Casey, was briefly filmed on board ship.

On arrival Geoff Merrill filmed the VW unloaded and driving at Mawson for the first time – the first production car in Antarctica. He filmed the VW driving around the base and up on the ice plateau, and as far inland as the Rumdoodle ice airstrip some 20 km from Mawson.

Around 20 minutes of film was shot over several days before the MV Nella Dan was due to depart, and the film was loaded back on board along with the returning expedition and shipped back to Australia. The film caused a sensation, with footage and stills from the film used for promotion all around the world. Shots of the Australian VW in Antarctica were used in VW advertising, here and in the USA. It was such a success that a visiting American team to Mawson a few years later admitted to the Australians that they would not have even known of Australia's scientific bases in Antarctica if not for the Volkswagen ads.

Geoff Merrill's footage was edited by Volkswagen Australasia and released as a general interest 16 mm film called 'Antarctica 1.' It ran for 10 minutes and was popularly shown in VW agencies, social clubs and schools for many years afterwards.

Not many prints are known to exist today. Our club was able to borrow a copy from Volkswagen Australia in the 1980s, and Steve Carter was able to video film it (by projecting the film onto a white sheet hung from a wall!) This became part of the club's VHS library, and later modernised by Phill Lander into our DVD library collection, under the care today of librarian Carl Moll.

There are a couple of posts on YouTube, which you can watch at any time. The quality however is not quite as good as our library copy. If you'd like to watch it, the link is:

[www.youtube.com/watch?v=Mdu8YGuj-ME](http://www.youtube.com/watch?v=Mdu8YGuj-ME)

There is another archive copy of the film in the National Library of Australia's collection in Canberra.

In March 2020 we received the following message on our website:

"Many years ago I was auditing the Antarctic Division of our Department and obtained an original 16mm copy of the first VW to be taken to the ice. It is still in my possession. Are you interested? Kind regards Bill Warriner."

We quickly replied that yes, we would be very grateful if we could borrow his copy of the 16 mm film and have it professionally transferred to digital (at our expense).

However Bill went one step further. He replied back: "You are welcome to the original which I received from the Antarctic Division photographer. I am sure your club would have much more use for it than I. I have already had the original professionally copied onto a USB stick. I have tried to send you an "E" copy but it appears the file is too long to send by email (some 2.1 GB). If you like I will send you a USB

copy via mail together with the film all for the cost of an honorary membership of your club. Have a nice day! Bill Warriner.”

And in due course, Bill sent both the USB stick – and the original 16mm film and canister – to our secretary Norm Elias. Thank you very much Bill!

The MP4 of the film plays very well, and when we return from covid lockdowns we will play it for the members at our monthly meeting so everyone can see it.

Bill's film copy is somewhat scratched and dirty for the first few minutes, with the picture quality not as good as what we already have in our library and a few jumps in tracking are evident. The sound track begins a little tinny in places and sounds exactly as we oldies remember from watching 16 mm films at school.

However the film soon clears up as the reel progresses and after a couple of minutes the picture and sound are better than we have seen. The picture is sharp and clean, and the colours are still bright. It is great to watch, and I can't wait to show everyone at a future meeting. I will also arrange for our improved version to be loaded onto YouTube in the near future, via Wayne Sole's channel.

But what to do with the 16 mm film?



We don't have a 16 mm film projector, and even if we did, every time a film is played it deteriorates slightly and can be damaged. Films also have to be stored properly. Modern cellulose acetate 'safety' films are far more stable than the dangerous old flammable nitrate films of the 1920s, but even in cold dry storage will decay over time with 'vinegar syndrome.' The acetate plastic stock gradually breaks down and releases acetic acid, which smells like vinegar. The longer this occurs the more brittle the film becomes, and it also gradually shrinks. The emulsion does not shrink, so it also gradually delaminates. Eventually the film becomes unplayable, and can even crumble to pieces. This process is greatly speeded up with poor storage, such as in rooms which are hot and humid. The process cannot be reversed, only delayed as long as possible. Copying to new stock, or digitising, before it is too late is the only way around the problem.

The National Film and Sound Archive in Canberra is



Australia's audio-visual archive, responsible for preserving, maintaining, promoting and providing access to our national collection of film, as well as television, sound and radio. Their collection spans over 150,000 films and 3 million items, spanning from the late 19th century to the present day (including over 4,000 Movietone newsreels). The NFSA have helped us before with preservation and copying of Volkswagen films in the early 1990s – see our old article here: [www.clubvw.org.au/media/oldarticles/oldart013/#cul05](http://www.clubvw.org.au/media/oldarticles/oldart013/#cul05)

The NFSA is the natural place to donate Bill's Antarctica 1 film for posterity.

It was necessary to fill out and submit a four-page 'Collection Offer Form' together with photos, describing the film in detail and why it was significant. Michelle Davenport from the NFSA was quickly in touch and was pleased to accept our offer to donate the Antarctica 1 film. I only had to box it securely and the NFSA paid for the courier to ship to Canberra.

[www.nfsa.gov.au/preservation](http://www.nfsa.gov.au/preservation)

It is a good feeling to know that the Antarctica 1 film will be preserved in the NFSA. Our children and grandchildren will have access to this wonderful piece of Australian Volkswagen and Antarctic history.

Thank you again to Bill Warriner for donating the film and the USB MP4 copy to us. They will be well looked after.

Phil Matthews

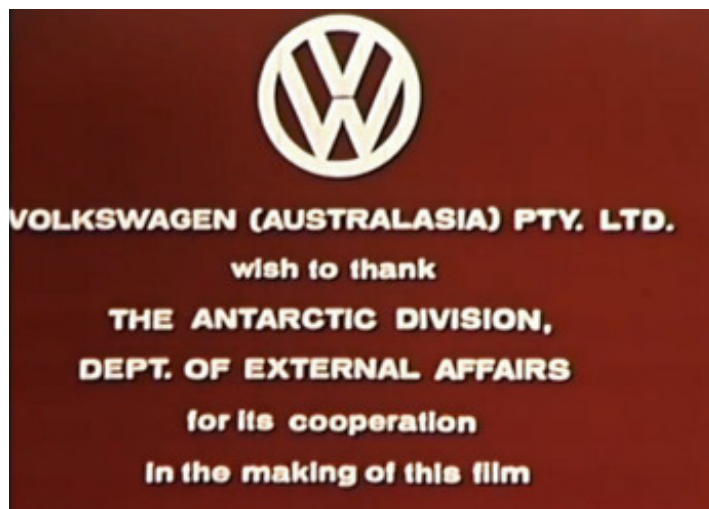

## Collectors' Corner.

This month we look at the first fully professional Volkswagen magazine published in Australia since the 1960s, which was 'Australian VW Power.'

After New Horizons (see last month's issue) closed in 1966, there would be no more Australian VW magazines produced for another 22 years. Throughout the 1970s and most of the 1980s, Australian VW enthusiasts had to be content with the Australian 'general' motoring magazines such as Wheels, Modern Motor and Australian Motor Manual (which later became Car Australia). These had occasional VW news items and local VW road tests and comparisons throughout the 1970s, but these became very infrequent from the early 1980s as local VW sales ended. Most of us had to get our VW fix in those days by buying Hot VWs, VW Trends and VW & Porsche from the USA, and Safer (VW) Motoring and VW-Audi Car from the UK.

The local VW scene was finally kick-started in the mid-1980s, firstly by the rise of modern VW clubs (such as ourselves!) and our first VW Nationals in 1988, but especially because of a change of VW importer. The old LNC Industries, which had owned VW Australia since the late 1960s, had become a motor industry conglomerate that concentrated on Subaru and Honda and numerous other makes. VW-Audi was only a tiny sideline by the mid-'80s. The VW Transporter and Audi 100 were the only models on sale, selling only a few hundred each year. Most of the 1970s VW dealers had closed or had moved over to other makes.

LNC lost the VW-Audi franchise in 1987 to ambitious importer Ateco, who had to restart the local VW-Audi business from scratch. New VW dealers were signed up. New models such as the Audi 80 and 90 and the latest T3 Transporter were introduced in 1988 ('Volkswagen is Back!'), followed by the Golf 1 Cabriolet and Golf 2 GTI in 1990. VW newspaper and TV ads reappeared for the first time in more than a decade. It was an exciting time - a feeling that the sleeping VW giant might finally be waking up in Australia.

Melbourne based Syme Magazines - a division of Syme Media Pty Ltd - saw the potential of a new title for local VW enthusiasts.

Syme Media had a long history of journalism and publishing in Australia. Scottish brothers David and Ebenezer Syme arrived in Australia in the 1850s to try their luck in the Victorian gold fields, with a modest amount of success. They were able to buy the struggling Melbourne Age newspaper in 1858. Under the Syme's management it soon became a great success as Melbourne's population boomed during the gold rush. Ebenezer died in 1860, leaving David in sole ownership of The Age. By the 1870s he was extremely wealthy and was involved in writing scientific books, funding universities and scientific expeditions and numerous philanthropic activities. He had five sons and two daughters and died in 1908. His good friend, the Prime Minister of Australia Alfred Deakin, called him "one of the greatest men in colonial history."

The Melbourne Age remained in the Syme family ownership after David's death. It was headed by Sir Geoffrey Syme from 1908 to 1942, and Oswald Syme from 1942 to 1964. The Age was eventually passed to Ranald McDonald, David Syme's great-grandson (Oswald Syme's grandson), who sold shares in The Age to Fairfax from 1972, and all ownership in 1983.

Syme Media's magazine division produced such titles as Trotting Weekly, Golf Australia, 4-Wheeler Australia and Caravan World. These came under Fairfax ownership from 1983, joining famous titles such as Woman's Day, People, Good Housekeeping and Dolly. In turn, Fairfax Magazines were bought by the Packer family's Australian Consolidated Press in 1988, joining their titles such as the Womens' Weekly, Australian House and Garden, Cleo and Wheels.

The 'specialist' Syme magazines were published under a division called 'ACP-Syme.' Their head office was in a small building at 603-611 Little Lonsdale St in Melbourne city, now long gone, bulldozed for a giant new office building.

## Australian VW Power.

Syme Magazines introduced a new title in December 1988, called 'Australian VW Power.' It was edited by Tim Britten, who had worked for other Syme motoring titles previously (and still contributes to the CarSales.com website today). The first issue was sub-titled 'Collector's Issue No. 1' and was 68 pages of black-and-white content with just 4 inside pages and the cover in full-colour. The magazine size was trimmed US 'Letter' or 'Size A', which is 8½ x 11 inches (216 x 279 mm), slightly wider but shorter than the modern metric A4 (210 x 297 mm). The trimming during the production process gave a finished magazine that was 8¼ x 10¾ inches (210 x 275 mm). It went on sale in newsagents for \$3.95.

In the first issue, editor Tim Britten announced the magazine in his Editorial:

"Not all people strike it lucky when they choose their life's vocation, but I suspect it's only very rarely that motoring writers feel mistreated by the vagaries of fate.

"Being a motoring writer is a bit like making a living out of passion. Once you're committed, it's nearly impossible to break free.

"Editing this first issue of Australian VW Power has not been without the odd hardship, but I'd be kidding myself if I said there wasn't a lot of fun involved, too. It's been a genuine labour of love.

"Launching a new magazine is always a gamble, always subject to gut-feeling more than it is to conclusive research-based data that tells you in advance what the buyer wants to read. You give your readers what you think they'd like to read, because you know what you like yourself. But you can only do this if you are a genuine enthusiast.

"I know my enthusiasm started in the 'fifties when I saw my first Beetle, powering up a hill so steep we used to take our pushbikes out there just to see how fast we were going by the time we reached the bottom. I think 80 km/h was about the most we were game to do, pushing off from a standing start at the precipice. When we saw this little car shifting down rapidly through the gears as it forged its way up we were impressed, and my mate told me it was one of those new Volkswagens, reputed to be faster than an FJ Holden.

"30-odd years later, this first issue of Australian VW Power is crammed with material I think is relevant to the fast-growing VW movement in this country today. From stories on the early war-time developmental days of the VW and early cars brought to Australia, to a look at latter-day interpretations of a design that is currently celebrating its 50th birthday.

"The idea of VW Power is not necessarily to emulate other VW magazines around the world. I think Australia is a



different market to, say, the U.S., not only because it's considerably smaller, but also because we tend to have different interpretations, a different approach to our VWs than that of the Americans. I think we're only just beginning to see what Australians can do with road-going VWs, and I hope this magazine can promote and encourage the movement by providing a showcase for the efforts of enthusiasts around the country, by giving each State a chance to show the rest what it's doing.

"Something I would particularly like, after this first issue has been examined by its readers, is to hear what you think of it. The things you liked, and the things maybe you didn't like - plus the things you may wish to see included in future issues. The next issue is planned for an on-sale date in mid-February 1989, so if you'd like to write to us, feel free to do so by mid-January 1989 at the latest.

"There are a lot of people, in and out of the industry, I'm indebted to for their cooperation in the compilation of Australian VW Power too; they are in fact too numerous to name, but they'll know who they are and I want to express my appreciation here - particularly to the advertisers who've supported our number one issue. Thanks for your confidence.

"There is another thing you can be sure of with this magazine too: like any new venture, this is only the beginning and as Australian VW Power proceeds, it will grow, and improve. We'll get better as we get wiser."

After just two issues, Tim Britten swapped places with his Assistant Editor David Morley, then from issue #5 they swapped back. (David Morley went on to work for Modern Motor (now called Motor) and retired at the end of 2020). Then from Issue 7, a new team under new editor Tony Glynn took over and lasted until the end of the magazine in 1992. Tony Glynn remained at Fairfax after that, but as a freelance travel writer for Holidays Away magazine among others, and is still contributing there today.

Australian VW Power was published every two months and sold well for several years. But they did contain many factual errors in their VW tech and history articles due to the writers being general auto journalists, rather than VW experts and/or enthusiasts specifically. Issue #3 and its infamous error-filled article on Karmann Ghias caused a lot

of controversy. Our then-Editor Dave Long pointed out VW Power's mistakes in Zeitschrift. They responded by threatening to withdraw support of the VW Nationals unless Dave apologised. He rightly refused to do so (VW Power didn't actually contribute any funding to the Nationals) but resigned over the matter. Read the saga on our website at [www.clubvw.org.au/media/oldarticles/oldart011/#con09](http://www.clubvw.org.au/media/oldarticles/oldart011/#con09)

Later issues mostly steered away from VW tech and history articles, but there were still some occasional very good ones by VW experts Jeff Unwin, Stephen Muller, Lance Plahn and Joe Kenwright. Most articles were colourful features of readers' cars, and reports and photos on various VW shows around the country. It was still a good effort, with some nice cars, four articles by the famous Larry Perkins and news on modern VWs as well as older VWs. There were a number of 'interview' style articles of then Ateco, TKM and Inchcape VW importer executives, and it's quite fun to read their thoughts now in light of how things turned out (VW Germany took over the whole Australian VW business and created today's Volkswagen Group Australia in 2001).

Nevertheless, it was great to have our very own Volkswagen magazine and the 21 issues are well worth collecting and reading today.

The magazine soon went up in size, to 76 pages in almost all issues, but a couple of early issues were 84 pages. The price gradually increased to \$4.20, then \$4.50, and finally \$4.95. The number of full-colour pages increased through its run, and the paper quality improved and became thinner and glossier. Article quality however dropped significantly over the last half dozen issues before the magazine folded, and an on-going series called Dub-Air (home-made light aeroplanes with VW engines) was particularly annoying.

So in the end there were 21 issues, dated from issue #1 in December 1988 to issue #21 in June/July 1992. There was no editorial or explanation or farewell in the last issue. Perhaps Syme Media just decided to pull the pin on the whole operation without any warning. No issue #22 ever appeared.

Here are all the issues of Australian VW Power. Check the issues you have, see which ones you're missing and tick them off as you add them to your collection.



Issue #1 December 1988

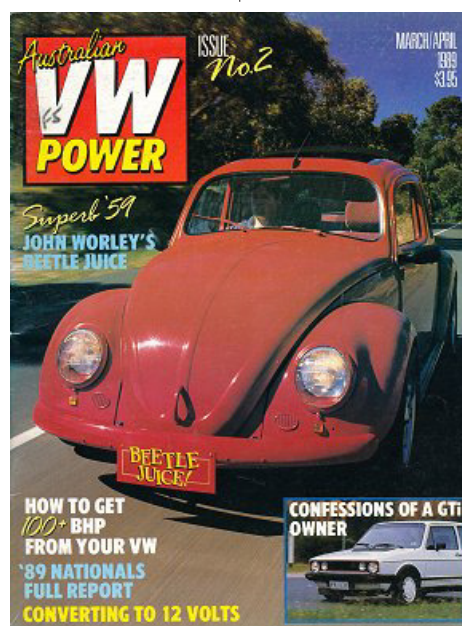

Issue #2 March/April 1989



Issue #3 May/June 1989



Issue #4 July/August 1989

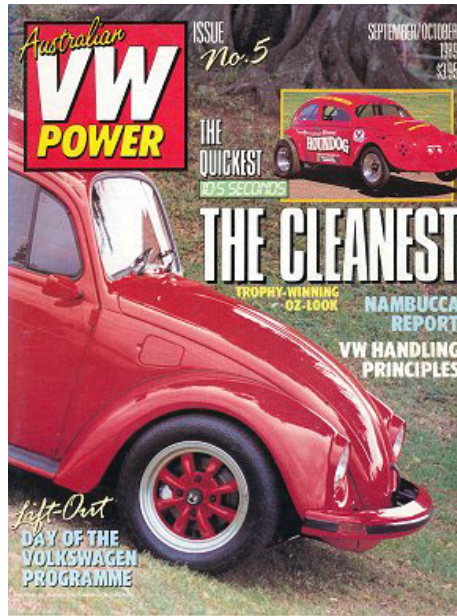

Issue #5 September/October 1989



Issue #6 December/January 1990

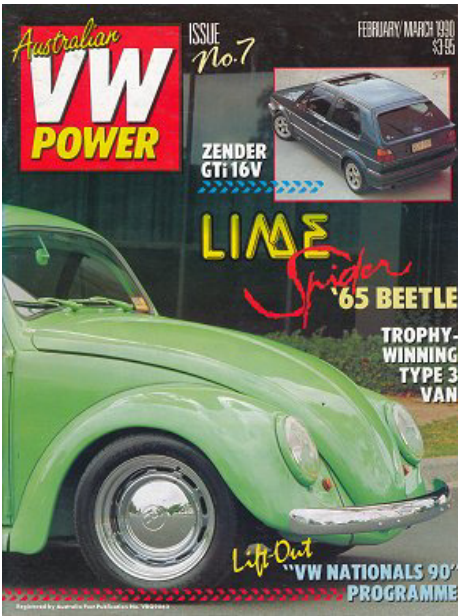

Issue #7 February/March 1990



Issue #8 April/May 1990

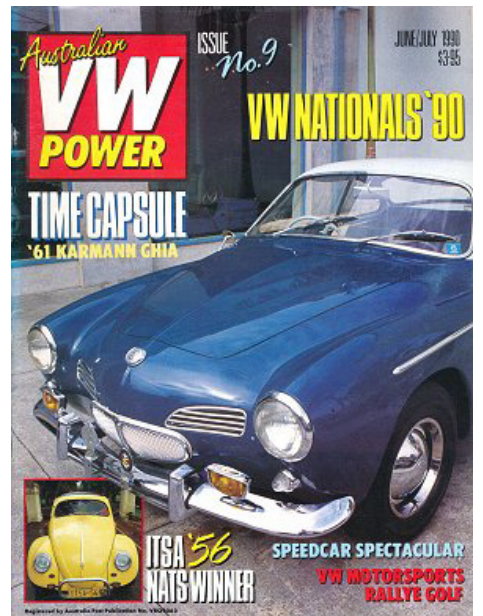

Issue #9 June/July 1990

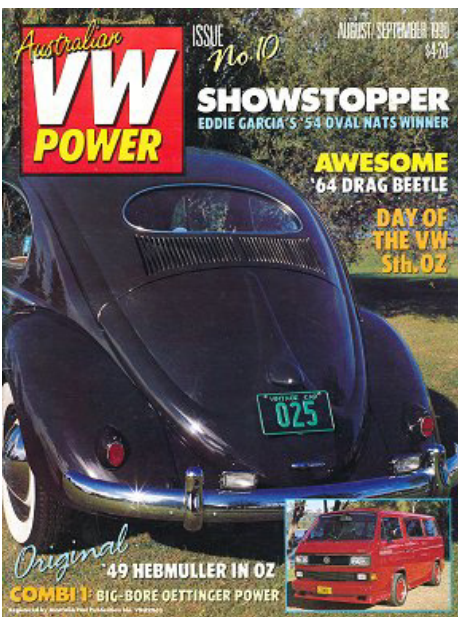

Issue #10 August/September 1990



Issue #11 October/November 1990



Issue #12 December/January 1991

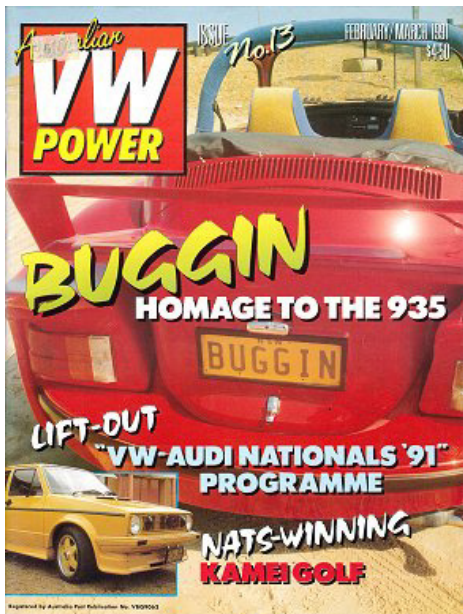

Issue #13 February/March 1991



Issue #14 April/May 1991



Issue #15 June/July 1991

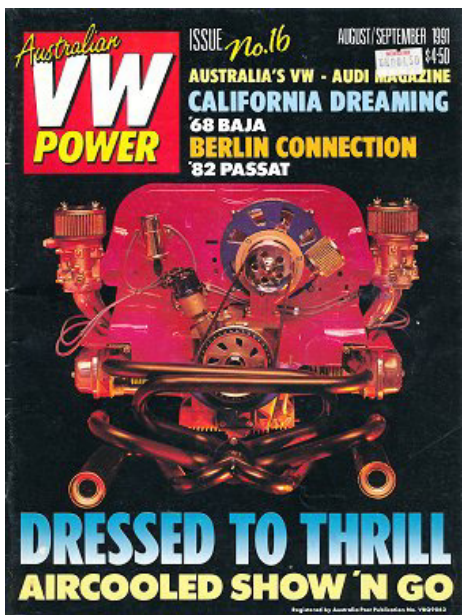

Issue #16 August/September 1991

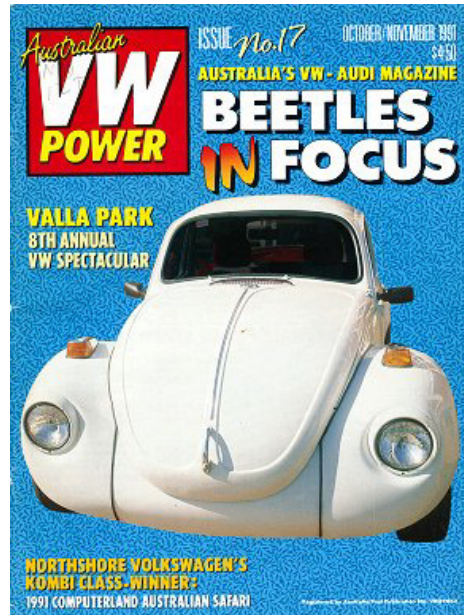

Issue #17 October/November 1991

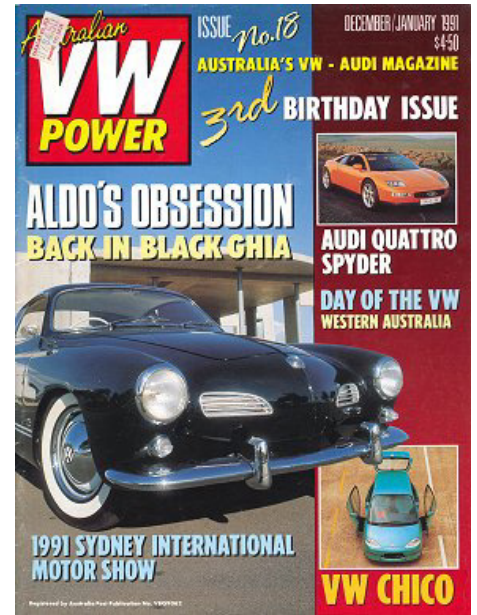

Issue #18 December/January 1991 ('92)

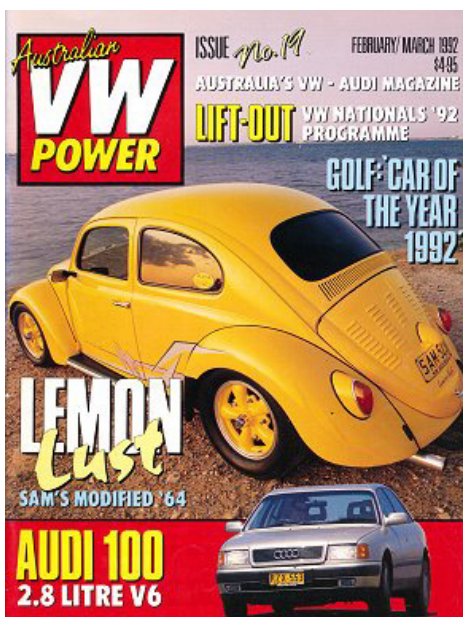

Issue #19 February/March 1992

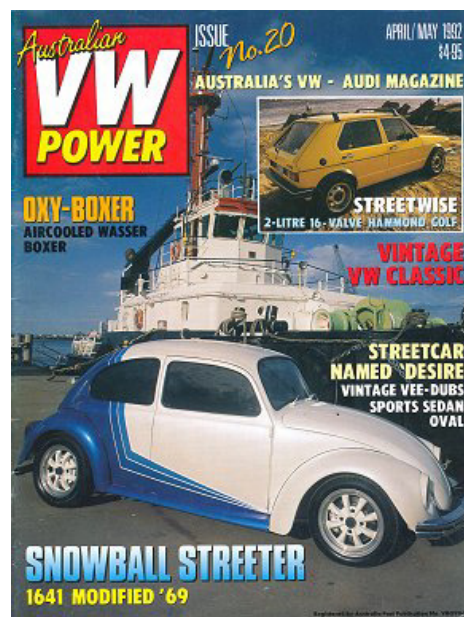

Issue #20 April/May 1992



Issue #21 June/July 1992

## VW39 1-00003.

The Volkswagen 39 may look to all intents and purposes just like an ordinary VW Beetle but it is, in fact, a little-known and rather special pre-series prototype designed by Ferdinand Porsche himself.

Porsche's Stuttgart design office had built a series of Volkswagen prototypes in the late 1930s in preparation for the start of production. The original Porsche Type 60 design from 1935 was built as a handful of VW1, VW2 and VW3 prototypes in 1936. The VW30 series of 30 prototypes followed in 1937, and the final pre-production series of 44 test cars called the VW38, in 1938. The VW38, with its 23.5-bhp 985cc engine, passed all its tests and was signed off to become the KdF-Wagen production vehicle.

In 1939 however, just before the beginning of the Second World War, Porsche built another series of just 14 improved VW prototypes called the VW39. The series was designed by Dr. Ferdinand Porsche as a high-speed variant, fitted with the modified engine and running gear from the better-known Type 64 'Berlin-Rome Racer.' The Type 64 engine was still 985cc but had larger valves and a higher compression ratio and produced 32 bhp, giving the VW39 a top speed of over 125 km/h.

Aside from the more powerful engine, the VW 39 prototypes were constructed using advanced machine tooling processes, and components like the wings and arched hood



were manufactured in a body press. While the KdF only entered very limited production of a few hundred cars before the war intervened, this production method would eventually be put into widespread use when the Volkswagen commenced large scale production after the war.

Only 14 of these VW 39 models were built, and just one exists today.

Chassis # 1-00003 spent its early years shuttling Ferdinand Porsche and his son between their bureau and workshops in Stuttgart, the KdF-Wagen factory in Wolfsburg (still under construction) and the capital Berlin. Porsche preferred the faster Type 64 cars with their streamlined bodies, and the VW39 eventually ended up in Berlin at the headquarters of the Deutsche Arbeitsfront (German Labour Front), the parent organisation of the Kraft durch Freude (KdF). Not much is known of the VW39's time there, but it somehow survived the war and was sold to a collector in Hamburg in 1948 in a rather poor state.



The car was found again in 1954 and ended up in the collection of the Raffay family in Hamburg. It was restored to the best ability of the day changing its colour from black to grey. It was used to promote his VW dealer business and was shown at several Volkswagen events through the years. It was last seen in 1991 in deteriorating condition and then locked away in their private collection. Unfortunately, this forgotten collection suffered from a serious building fire in the mid-2000s, destroying a number of vehicles and seriously damaging the rest.

It was in this state that Thomas König and Oliver

Schmidt, the founders of the Hamburg Prototype Museum, purchased the VW39 prototype approximately six years ago. It was little more than a burned out shell.



Following a five-year ground-up restoration by a team of renowned German early VW specialists and parts collectors, which involved the complete rebuilding of the car and the manufacture of many components by hand, it is now finished in its original Nitro Black paintwork and as pristine as the day it left the factory all those years ago.



Noticeable details are the vertical fold on the now arched bonnet, the concave bumper horns and the improved interior heating. The nameplate identifies this vehicle as a Porsche. New and defining for all subsequent models is the chassis number, which begins with a '1', followed by a hyphen and a five-digit number, which already suggests a series production. After several years of restoration, this unique 'pretzel' beetle is now part of the permanent exhibition at the Prototyp Automuseum in Hamburg.

[www.prototyp-hamburg.de/en/](http://www.prototyp-hamburg.de/en/)

It is the 4th oldest VW/KdF in the world (excluding the Berlin-Rome racer). The last surviving member of its small production run, chassis # 1-00003 is a rather special car and further proof of the humble Beetle's impressive legacy.



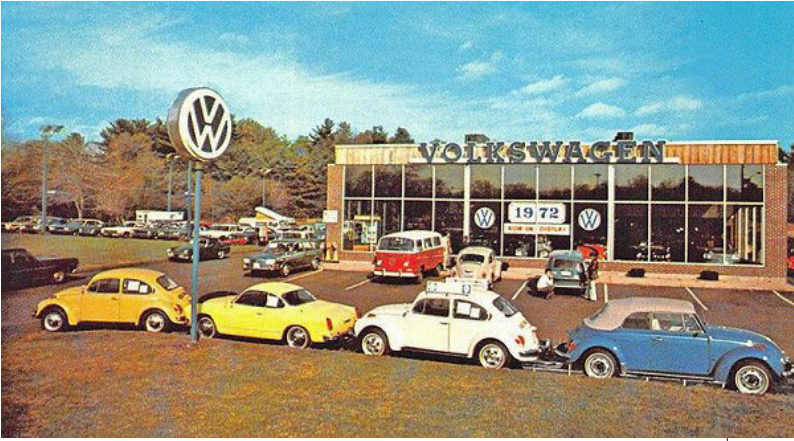

## Secrets of new car care.

*The Sydney Morning Herald, Monday 4 September 1972*

You have a new car and you want to preserve that new car feeling. There are so many ways you can do this, and when the car is new it does not take too much time.

A little time spent when the car is new, pays off, not only in a better-looking car but also in a higher trade-in later on.

Auto companies build to a high standard and it is the dealer's job to see that your car is delivered to you without defects.

The rule that prevention is better than cure is a good one when it comes to cars.

Some defects appear only after you have had your car for a while and they are always harder to fix as time goes by.

First, let us look at the paint work. All companies now use high quality acrylic enamels or lacquer and these paints are very durable. It makes sense, however, to apply a good quality polish as soon as you get your new car home. This is very important for the horizontal surfaces such as the bonnet, roof, etc.

Use polish which leaves a protective wax on the painted surface. Take care not to use a polish with a 'cutting' or 'abrasive' action, particularly if your paint colour is a metallic or iridescent finish. These finishes have aluminium particles in them and when they are sprayed, the aluminium sinks down leaving a clear resin 'skin' on top.

Cutting-type polishes will cut down this skin and reduce the weather resistance of your paint. If you can't get a wax polish coat put on as soon as you get your car home, do it as soon as possible but take care to wash the car first. Use warm water and auto detergent, wash, dry thoroughly and apply polish. The thing to remember is that it is better for the 'fall out' from our polluted air to fall on to the wax coat, than on to your new paint.

### Thinners

Now take a good look at all sharp edges of panels, doors, etc. This is where paint is most likely to be thin or chipped.

Ask your dealer for a small quantity of lacquer the same colour as your car and some thinners to break it down. Be sure you get the correct thinner to go with the lacquer and

use one part lacquer to two parts thinners.

Use this for all chips, scratches or sharp edges of panels, where paint is thin. Use a soft artists brush and brush on several coats to build up the paint thickness.

It's possible to buy pressure packs of certain car companies' colours but be very cautious with these, particularly with metallic colours. You can get some very poor colour matching effects.

If you have a metallic colour do not use an aerosol pack to try to repair a scratch or chip in the middle of a panel. The only way to repair this is with a tradesman's spray gun . . . and his experience.

Take a close look at those bright mouldings and nameplates, particularly where they are on painted surfaces. Look to see if they have cut into the paint, particularly at the ends. This is where a rust stain will soon appear.

The reason for rust appearing so quickly is that two different metals are in contact and this causes rapid chemical corrosion. It will not rust a hole in your car but it does look unsightly, particularly on light coloured cars.

Fix this problem by carefully lifting moulding edge, spotting the damaged paint surface, first cleaning any light rust away if present, and then putting a small piece of clear plastic sheet under the moulding.

This acts as an insulator between the two metals. It's always a good idea to work some of that waxy polish right along the back edges and ends of all bright metal parts that are in contact with painted panels, or if you want to be extra careful a light smear of a petroleum based anti-rust compound is even better. These materials are obtainable from dealers and accessory shops.

The next step in your program should be to inspect all places on the car where the panels overlap or are joined. Some of these areas are sealed and painted over, others are not meant to be - to allow panels to flex. Check those areas which are meant to be sealed and painted - good examples are around edges of doors, bonnets, boot lids, etc. If any breaking of the paint is showing, reseal with air-drying vinyl repair sealer - obtainable from your dealer in tubes - and touch up the repair with lacquer.

If you are really keen go over all the joints around the engine compartment and in the boot and seal the joints where two pieces of metal over-lap. Use the vinyl sealer and touch up with lacquer. Even if you do not seal these joints, work some of the anti-rust compound into them.

The last job on the list should be to make screws, nuts,



clips, etc. more resistant to rust.

Many of these parts have protective coatings, but some have none at all and they look unsightly when rusty. Go around the car and shoot a short spray of rust preventative from an aerosol pack on to all visible bits of hardware. If you do not have an aerosol pack then use the petroleum-based anti-rust oil mentioned earlier. If you have an old can of clear varnish around the workshop that will do the job. Just brush a little on to each part.

Do not overlook your accessories, such as roof racks, wind deflectors, etc. These often are not protected as well as your factory-built car.

All of these jobs will take only a day to do but you will be rewarded with a better looking and protected car which you can be proud of.

Peter Llewellyn



## A man's age according to Bunnings.

Let's say you are in the middle of some kind of handyman project around the house - mowing the lawn, putting in a new fence, fixing the side gate, painting the living room or whatever. You are hot and sweaty, covered in dust, lawn clippings, dirt or paint. You have your old work clothes on - you know the outfit: shorts with the hole in the crotch, an old T-shirt with a stain from who-knows-what and a grubby old pair of tennis shoes.

Right in the middle of this great home improvement project, you realize you need to whip over to Bunnings to get something to help complete the job. Depending on your age you might do the following:

### In your 20's:

Stop what you are doing. Shave, take a shower, blow dry and style your hair, brush your teeth, floss and put on fashionable clean clothes. Check yourself in the mirror and flex. Add a dab of your favourite cologne because you never know, you just might meet some hot chick while standing in the checkout queue. Why is Bunnings always full of old farts? You find out you went to school with the pretty girl running the register.

### In your 30's:

Stop what you are doing, put on clean shorts and shirt. Change shoes. You're married now so no need to try much else. Wash your hands and comb your hair. Check yourself in the mirror. Yep, still got it. Add a shot of your favourite cologne to cover the smell. Cruise into the Bunnings carpark in your custom VW. The cute girl running the register is the kid sister to someone you went to school with.

### In your 40's:

Stop what you are doing. Put on a sloppy joe that is long enough to cover the hole in the crotch of your shorts. Put on different shoes and a hat. Wash your hands. Your bottle of Brut-33 cologne is almost empty so you don't want to waste any of it on just a trip to Bunnings. Check yourself in the mirror and do more sucking in than flexing. The hot young thing running the register is your daughter's age and you feel weird thinking she is spicy.

### In your 50's:

Stop what you are doing. Put on a hat; wipe the dirt off your hands onto your shirt. Change shoes because you don't want to get dog poo in your classic Volkswagen. Your bottle of Old Spice is empty and you can't find anywhere that still sells it. Check yourself in the mirror and you swear not to wear that shirt anymore because it makes you look fat. The Cutie running the register smiles when she sees you coming and you think you still have it. Then you look down and see your fly is undone.

### In your 60's:

Stop what you are doing and make out an itemised shopping list. No need to get changed or put on a cap; you'll be taking your wife's car. Hose the dog poo off your shoes. You check yourself in the car's rear vision mirror and pat what's left of your hair down. You hope you have underwear on so nothing hangs out the hole in your pants. Realise you left your list at home. The girl running the register may be cute, but you don't have your glasses on so you are not sure.

### In your 70's:

Stop what you are doing. Wait to go to Bunnings until the chemist has your prescriptions ready, too. You don't even notice the dog poo on your shoes. Why is the car park so far from the store? Bunnings seems to be a bit breezy. The young thing at the register stares at you and you realize that something is hanging out the hole in your crotch.

### In your 80's:

Stop what you are doing. Start again. Then stop again. Now you remember - that's right, you need to go to Bunnings. Go to K-Mart instead and wander around trying to think what it is you are looking for. You went to school with the old lady who greeted you at the front door. Fart out loud and you look around, thinking someone called out your name.

### In your 90's & beyond:

What's Bunnings? Say again? Something for my garden? Where am I? Who am I? Why am I reading this? Did I send it? Did you? Who farted?

Marge Horstman

# Jeff's Facebook finds.



Like Comment Share



9:58 [weather] [notifications] [apps] ...

Mac Pack ▶ Old Motor Racing Photographs - Australia

9 mins • [location]

Happy Bathurst day, my 64 Beetle in the 64 Armstrong 500 and as she is today.

30 1 Comment

Like Comment Share





Like Comment Share



Like Comment Share



**Attention VOLKSWAGEN Owners**

C.O. CRANKCASE — £37/10/- COMPLETE WITH B.E. SHELLS

£26/10/6 C.O. Cylinders with Conrods

£5 C.O. Flywheel

£5 C.O. Crankshaft and Bearings

£5 C.O. Pressure Plate

Short Motors are also stocked. Free pick-up and delivery. Finance arranged. Trade inquiries welcomed.

**W. HEWISON & SON PTY. LTD.**  
62-64 NORTH STREET, RICHMOND. 42 6138, 42 6139.



**VW SALE**

70 AUDI 100 LS. 4000 Miles. Director's car. Radio . . . . .	P.O.A.
70 VW F/BACK T.L.E. Fuel injected. As new. Radio . . . . .	\$2590
70 VW 1500 BEETLE Current series. As new. Radio . . . . .	\$1890
89 VW AUTOMATIC BEETLE. 12 months reg. 18,000 miles . . . . .	\$1590
89 VW 1800 SED. 12 months reg. 14,000 miles . . . . .	\$1690
88 VW 1300 DELUXE SED. 12 months reg. One owner. Radio. . . . .	\$1490
87 VW 1600 F/BACK. One owner. Radio . . . . .	\$1390
87 AUDI SUPER 80. 33,000 miles. Immaculate. Radio . . . . .	\$2490
86 VW SEDAN. Weekend special . . . . .	\$790
82 VW DELUXE SEDAN. Better than average . . . . .	\$890
59 VW SEDAN. Faultless condition. Long reg. . . . .	\$490

**OTHER MAKES**

70 MORRIS NOMAD 1500. As new. 2000 miles. O/drive, . radio	\$2190
80 MINI MOKE. One owner. As new. Heater . . . . .	\$990
89 CAPRI 1600 G.T. 11,000 miles with service. Recond. Radio . . . . .	\$2290
88 MORRIS COOPER S. One owner. Immaculate condition . . . . .	\$1390
88 VALIANT AUTOMATIC SEDAN. 160 Motor, radio, heater . . . . .	\$1590
86 HOLDEN HR SEDAN Automatic. 186 motor . . . . .	\$1390
82 AUSTIN A40 COUNTRYMAN. 12 months reg. Radio . . . . .	\$490

219 HEIDELBERG ROAD

**Smiths FAIRFIELD**  
48 2154  
A.H. 89 2165

## Laughs in Lockdown.

My mate just got back from the Himalayas. He said to me, I climbed to the top of the world's highest mountain! I said wow, Everest? He said sure, about every 50 metres or so.

Classic TV cartoon The Flintstones is gaining popularity in the Middle East. Not many people in Saudi Arabia like it, but all the viewers in Abu Dhabi do.

In Romeo and Juliet, Shakespeare wrote about the moon being sick and pale. It was probably a phase it was going through.

A truck accidentally dropped a big pile of trousers on the street. I decided to pick up the slack.

Nineteen young blondes lined up together at the cinema ticket box. The sales lady asked why there were so many of them in the group. The blonde at the front said "The film is only for 18 and over."

I went on a first date with a girl last week. I didn't know that she had false teeth. But some things come out in conversation.

My mate at work was thinking of getting a dog as a family pet. I suggested that as they are great with kids he should get a Labrador. Bigger that, he said. Have you seen how many of their owners go blind?

My girlfriend thinks that I'm a stalker. Well, she's not exactly my girlfriend yet.

Just imagine if they made pencils with rubbers at BOTH ends. But what would be the point?

Two Muslims crashed their speedboat into the wall at Warragamba. Police think that it might be the start of Ramadama.

Tommy Emmanuel was held up in the street by a bandit. The robber screamed "Gimme your guitar, hand it over or else." Tommy replied "oh yeah, is that a fret?"

I was sitting opposite an old Indian lady on the train yesterday. She shut her eyes and stopped breathing. I thought she might be dead, but then I saw the red spot on her forehead. I realised she was just on standby.

Police are chasing a criminal who has stabbed six people in the back over the last 48 hours, using large knitting needles. They believe the attacker could be following some kind of pattern.

It was such a beautiful wedding. The groom was handsome, and the bride was just gorgeous. Everyone was crying. Even the cake was in tiers.

It was reported that a woman stole a saxophone from the orchestra. Police charged her with grand theft alto.

I saw a blonde in the Post Office yesterday, talking loudly into an envelope. When I asked her what she was doing, she said she was sending a voicemail.

A Pakistani fellow has moved in next door. He told me that he has travelled the world, been scuba diving and parachuting, eaten at the best restaurants, hunted tigers and bears, raced cars, sailed yachts and climbed mountains. I wasn't surprised to learn his name was Bindair Dundat.

The timber cutter changed into his pyjamas. He had been invited to a lumber party.



My local dentist won an award for Dental Technician of the Year. No cash prize, but he did get a little plaque.

I heard that our local pancake restaurant is haunted. It's in a creepy old building, and people have seen some ghosts there. The place gives me the crepes.

The witch decided to publish a book on all her favourite potion recipes, but it was a failure. She forgot to run a spell check.

My washing machine broke, and I couldn't work out how

to fix it. So I threw in the towel.

The Bondi life-saver wasn't able to save the drowning hippy. He was too far out man.

Years before he became Batman, Bruce Wayne used to work in a posh restaurant as a pastry chef. In those days he was called the Crepe Crusader.

Those new reversing cameras for large VWs such as Tiguan, Touaregs and Transporters are great. I got one, and I never looked back.

The stone statue of Captain Cook in Hyde Park decided to leave his pedestal. He was tired of being taken for granite.

It was reported that in a survey of old Disney movies, everyone still loves Snow White and Pinocchio, but no one watches Dumbo any more. That movie is totally irrelevant.

Han Solo cruised the Millennium Falcon through the space drive-through and ordered a burger. But it was a bit Chewy.

There was a robbery at the Apple Store. Luckily, police caught the criminal, thanks to an iWitness.

# Volkswagen gives you more in the end.

The sharp end of our highly successful van is a very pleasant place to work. You don't snare nearly 50% of the 1 ton market without the cab comfort, safety and air flow conditioning we build in.

Strangely though, the things that follow our comfortable office around are a little less famous. There they are on the right. Five very functional tails including a brand new design we call the "high topper". More head room and 25% more space for tall orders. So whatever kind of work you do, there's a VW 1 tonner that works.

Oh, one other thing: money.

Volkswagen gives you more of that in the end too.

### History making trade-ins guaranteed.

Happily for you there are more buyers looking for used VW vans than there are used VW vans. So, right now, used VW's are fetching remarkable prices. Guaranteed trade-ins are higher than they have ever been. Trading-in or buying for the first time, it's nice to know VW's really do hold their value better. And if cash is a bit tight with you, you can still own Australia's most popular 1 tonner, easily.

### Australia's cheapest leasing deal.

All you pay is \$78 a month; no capital outlay and your trade-in, cash in your hand to put back in your business. That's about 17% cheaper than any comparable lease deal. And that's pretty smart business. Regardless of the vehicle you drive, go see your VW dealer. You'll live happily ever before, during and after. The end.



Volkswagen Australia Pty. Limited  
(A Division of INC Industries Ltd.)

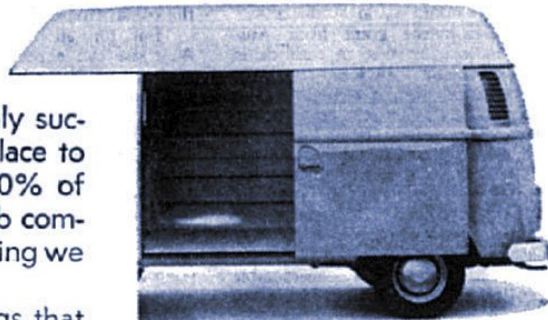

High Topper

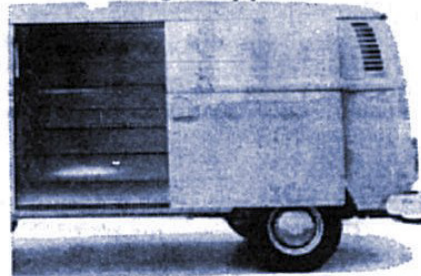

Delivery Van

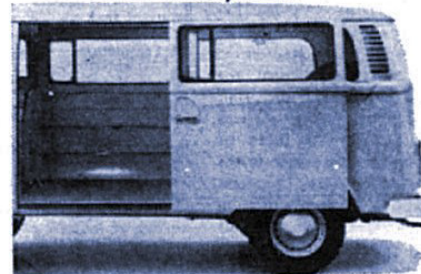

Kombi Van

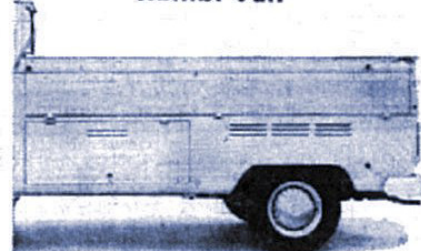

Single Cabin Pick-up



Double Cabin Pick-up

VW848-145

# VW NATIONALS Sponsors 2021.

We wish to extend a sincere *thank you* to all of our sponsors below, who made the VW Nationals 2021 possible. Please support them, because they support us.

Air-Cooled Garage	QLD (07) 5415 0633
All Metal Bumpers	0438 765 098
Andrew Dodd Automotive	(02) 9683 2184
Antique Tyres	VIC (03) 9458 4433
Artemi's T-Shirts	0415 163 313
Australian VW Performance	VIC (03) 9725 5366
Black Needle Motor Trimming	(02) 4722 5333
BWA Auto	(02) 9838 7373
Cafe Express	0414 263 333
Canberra VW Centre	ACT (02) 6253 1481
Das Resto Parts	QLD (07) 5568 0143
Euro Revolution	0410 541 322
Eurohub Australia	<a href="http://www.eurohubaustralia.com">www.eurohubaustralia.com</a>
Evolution Car Hire	0419 494 465
Forty Horse T-Shirts	0404 092 551
German Performance Garage	(02) 9899 9900
H & M Ferman	(02) 9533 2722
Harding Performance	QLD 1300 730 949
Haus of Brown	(02) 9724 5901
Jay Leno's Garage	<a href="http://www.jaylenosgarage.com.au">www.jaylenosgarage.com.au</a>
Just Kampers Australia	(02) 9645 7660
Kombi Crazy Collectables	0439 336 614
Kombi Shop	QLD (07) 5471 0331
Kustom Kombi	QLD 0414 857 259
MacKellar Service Centre	(02) 9939 2467
Mick Motors	QLD (07) 3266 8133

Mobile Auto Models & Toys	0403 012 060
Motexion Bulkheads	1300 563 333
Mountain Mechanics	0418 426 487
Mullerhaus	0412 449 389
Newcastle VW Centre	(02) 4927 6689
North Rocky Mechanical	QLD (07) 4922 0555
Quik Strip Padstow	0418 440 131
Rod Penrose Racing	(02) 4272 9920
Shannons Classic Car Insurance	13 46 46
Stan Pobjoy Race Engineering	(02) 6654 3694
Tin God Solutions	VIC 0419 875 905
Top Stitch Motor Trim	0422 216 935
VanEssa Mobilcamping	1300 221 000
Vintage Vee Dub Supplies	(02) 9789 1777
Volksbahn Autos	(02) 9688 2933
Volkscare	VIC (03) 9729 9281
Volkshome Automotive	VIC (03) 9464 0366
Volkwerke	VIC (03) 9840 6449
VW Magazine Australia	QLD (07) 3806 1240
Warby's VW Stickers	0423 113 654
Wayne Penrose VW	0419 481 461
Wolfsburg Automotive	VIC 1300 370 310
Wolfsburg Motors Sydney	(02) 9519 4524
Yehaar VW Glassware	0401 156 900
Zelicious Woodfire Pizza	1300 059 960



**VOLKSWAGEN**  
GROUP AUSTRALIA